

Throttle check valve

Type Z2FS



- ▶ Size 6
- ▶ Component series 4X
- ▶ Maximum operating pressure 350 bar
- ▶ Maximum flow 80 l/min

Features

- ▶ Sandwich plate valve for use in vertical stackings
- ▶ Porting pattern according to ISO 4401-03-02-0-05 and NFPA T3.5.1 R2-2002 D03 (**with** or **without** locating hole)
- ▶ For the main or pilot flow limitation of 2 actuator ports
- ▶ For supply or discharge throttling
- ▶ 3 adjustment types:
 - Setscrew with lock nut and protective cap
 - Lockable rotary knob with scale
 - Spindle with internal hexagon and scale
- ▶ Corrosion-protected design optional

Contents

Features	1
Ordering code	2
Symbols	3
Function, section	4
Technical data	5
Characteristic curves	6
Dimensions	7
Accessories	8
Further information	8

Ordering code

01	02	03	04	05	06	07	08	09	10
Z2FS	6			- 4X	/				*

01	Throttle check valve	Z2FS
02	Size 6	6
03	Throttle check valve side A and B	- ¹⁾
	Throttle check valve side A	A
	Throttle check valve side B	B

Adjustment type

04	Setscrew with lock nut and protective cap (versions "J3" and "J5" without protective cap)	2
	Lockable rotary knob with scale	3 ²⁾
	Spindle with internal hexagon and scale	5
05	Component series 40 ... 49 (40 ... 49: unchanged installation and mounting dimensions)	4X
06	With fine adjustment	1Q
	Standard version	2Q

Corrosion resistance (outside)

07	None (valve housing primed)	no code
	Improved corrosion protection (240 h salt spray test according to EN ISO 9227)	J3 ³⁾
	High corrosion protection (720 h salt spray test according to EN ISO 9227)	J5 ³⁾

Seal material (observe compatibility of seals with hydraulic fluid used, see page 5)

08	NBR seals	no code
	FKM seals	V
09	Without locating hole	no code
	With locating hole	/60 ⁴⁾
10	Further details in the plain text	*

- 1) Identical adjustment types on sides A and B
- 2) H-key with material no. **R900008158** is included in the scope of delivery.
- 3) Only adjustment types "2" and "/60"
- 4) Locking pin ISO 8752-3x8-St, material no. **R90005694** (separate order)

**Notes:**

- ▶ For valve types for use in potentially explosive atmospheres, refer to data sheet 07011.
- ▶ Preferred types and standard units are contained in the EPS (standard price list).

Symbols (① = component side, ② = plate side)

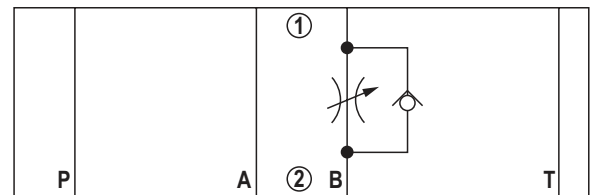
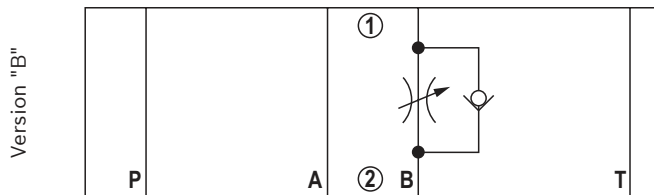
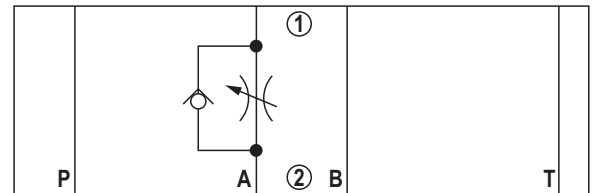
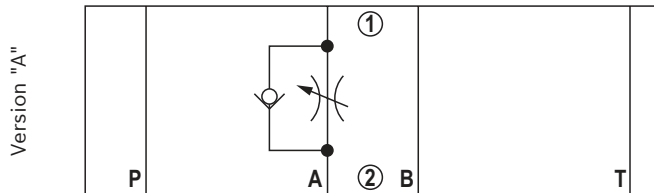
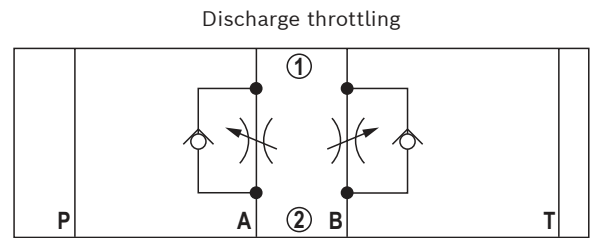
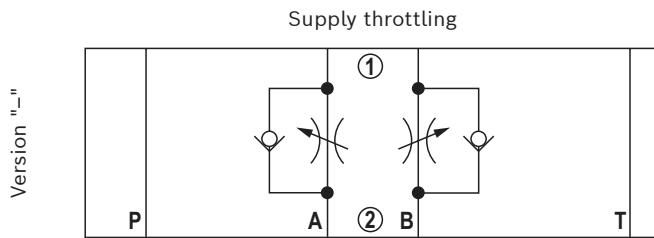

Notice:

Modification from supply to discharge throttling is realized by horizontal rotation of the device

Function, section

The valve type Z2FS is a throttle check valve in sandwich plate design. It is used for the main or pilot flow limitation of one or two actuator ports.

Two throttle check valves aligned symmetrically to each other limit flows in one direction and allow free return flow in the opposite direction.

In case of supply throttling, the hydraulic fluid is directed via channel A① via throttling point (1) formed by the valve seat (2) and the throttle spool (3) to actuator A②. The throttle spool (3) can be axially adjusted via the set-screw (4) for adjustment of the throttling point (1).

The hydraulic fluid return flow from actuator A② displaces the valve seat (2) against the spring (5) in the direction of the throttle spool (3) and enables the unobstructed flow as check valve. Depending on the installation position, the throttling effect may occur in supply or discharge.

Main flow limitation (version "2Q")

For actuator velocity adjustment (main flow limitation), the throttle check valve is installed between the directional valve and the subplate.

Pilot flow limitation (version "1Q")

With pilot-operated directional valves, the throttle check valve can be applied for switching time adjustment (pilot flow limitation). In this case, it is installed between the pilot control valve and the main valve.

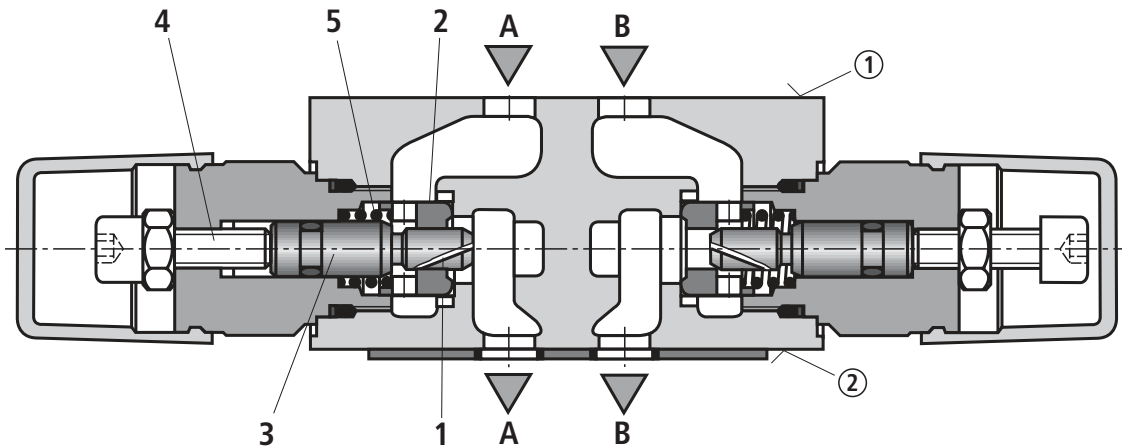

Type Z2FS 6 -2... (supply throttling)

① = component side

② = plate side

Technical data

(For applications outside these values, please consult us!)

General				
			Z2FS6A./...Z2FS6B./...	Z2FS6.-./...
Weight	▶ Version "2"	kg	0.9	1.0
	▶ Version "3"	kg	1.1	1.4
	▶ Version "5"	kg	1.0	1.2
Installation position			any	
Ambient temperature range		°C	-30 ... +80 (NBR seals) -20 ... +80 (FKM seals)	
Storage temperature range			see operating instructions 07600-B	
Hydraulic				
Maximum operating pressure		bar	350	
Maximum flow		l/min	80	
Maximum leakage (at Δp 350 bar)		l/min	< 1	
Hydraulic fluid			see table below	
Hydraulic fluid temperature range		°C	-30 ... +80 (NBR seals) -20 ... +80 (FKM seals)	
Viscosity range		mm ² /s	10 ... 800	
Maximum admissible degree of contamination of the hydraulic fluid, cleanliness class according to ISO 4406 (c)			Class 20/18/15 ¹⁾	

Hydraulic fluid	Classification	Suitable sealing materials	Standards	Data sheet
Mineral oils	HL, HLP, HLPD, HVLP, HVLPD	NBR, FKM	DIN 51524	90220
Bio-degradable	▶ Insoluble in water	HETG	ISO 15380	90221
		HEES		
	▶ Soluble in water	HEPG	ISO 15380	
Flame-resistant	▶ Water-free	HFDU (glycol base)	ISO 12922	90222
		HFDU (ester base)		
		HFDR		
	▶ Containing water	HFC (Fuchs: Hydrotherm 46M, Renosafe 500; Petrofer: Ultra Safe 620; Houghton: Safe 620; Union: Carbide HP5046)	ISO 12922	90223



Important information on hydraulic fluids:

- ▶ For further information and data on the use of other hydraulic fluids, please refer to the data sheets above or contact us.
- ▶ There may be limitations regarding the technical valve data (temperature, pressure range, life cycle, maintenance intervals, etc.).
- ▶ The ignition temperature of the hydraulic fluid used must be 50 K higher than the maximum surface temperature.
- ▶ **Bio-degradable and flame-resistant – containing water:** If components with galvanic zinc coating (e.g. version "J3" or "J5") or parts containing zinc are used, small amounts of dissolved zinc may get into the hydraulic system and cause accelerated aging of the hydraulic fluid. Zinc soap may form as a chemical reaction product, which may clog filters, nozzles and solenoid valves – particularly in connection with local heat input.

▶ Flame-resistant – containing water:

Due to the increased cavitation tendency with HFC hydraulic fluids, the life cycle of the component may be reduced by up to 30% as compared to the use with mineral oil HLP. In order to reduce the cavitation effect, it is recommended - if possible specific to the installation - to back up the return flow pressure in ports T to approx. 20% of the pressure differential at the component.

¹⁾ The cleanliness classes specified for the components must be adhered to in hydraulic systems. Effective filtration prevents faults and simultaneously increases the life cycle of the components.

For the selection of filters, see www.boschrexroth.com/filter.

Characteristic curves

(measured with HLP46, $\vartheta_{oil} = 40 \pm 5 \text{ }^\circ\text{C}$, averages)

Δp - q_v characteristic curves (version "2Q")

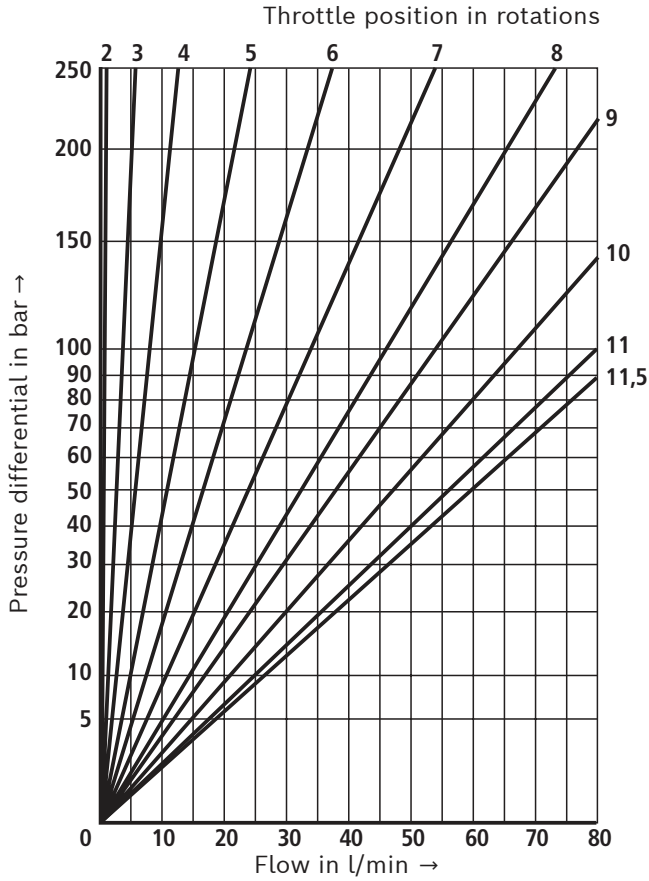

Δp - q_v characteristic curves (version "1Q")

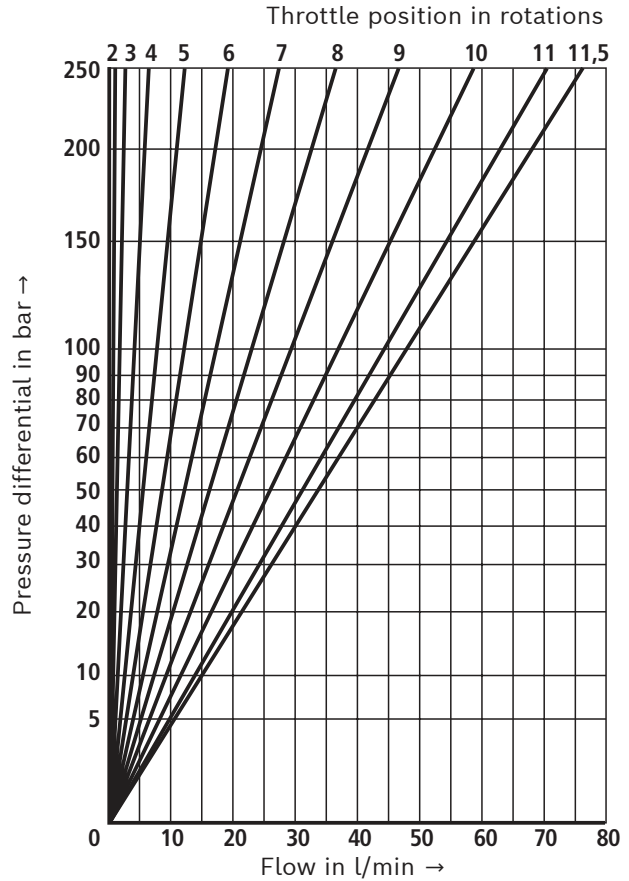

Δp - q_v characteristic curves

(via check valve; throttle closed)

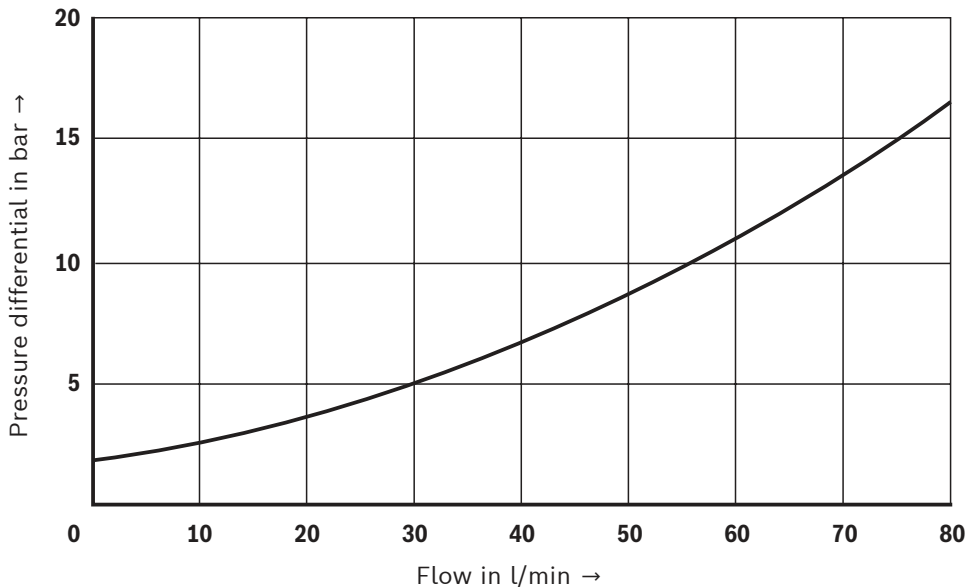

Dimensions

(dimensions in mm)

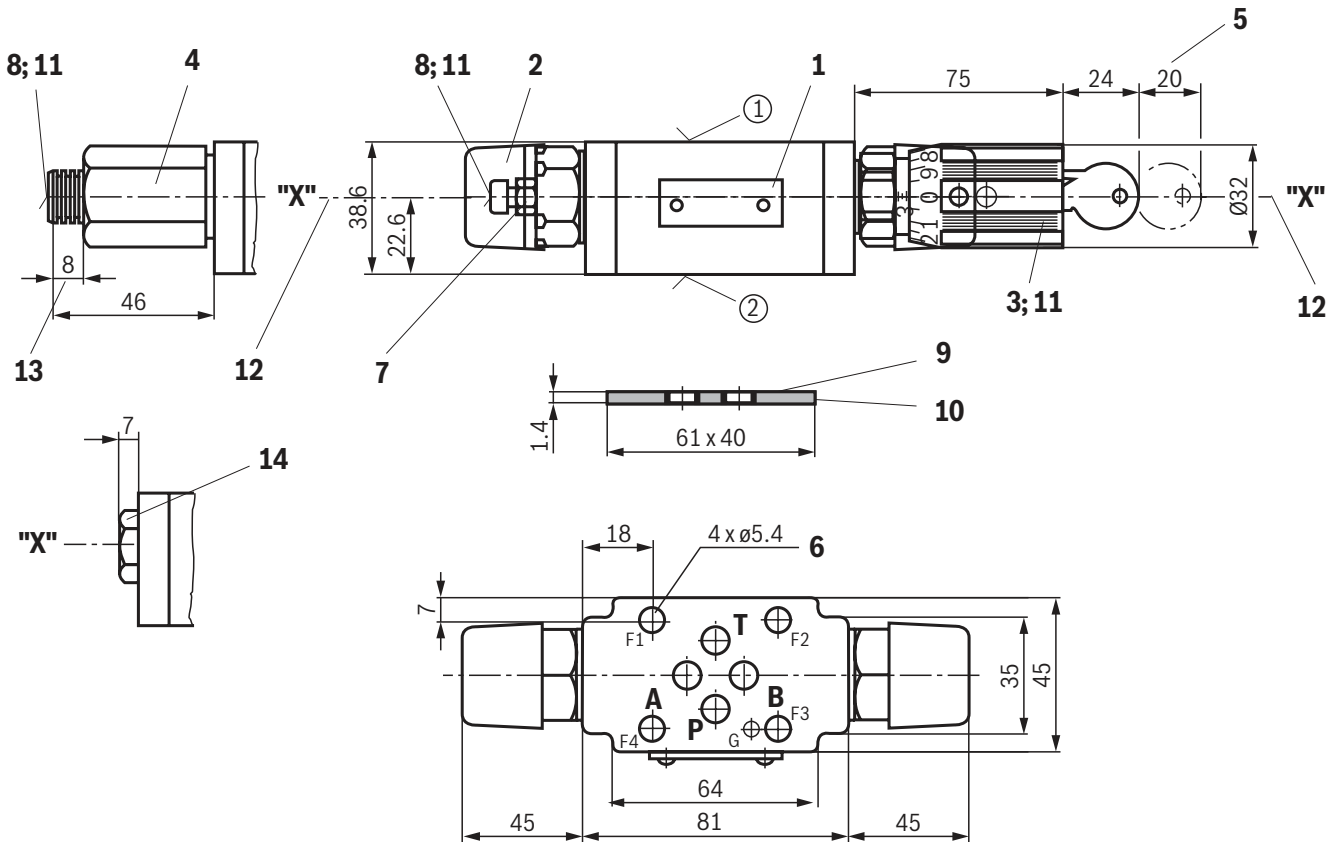

Notice:

The dimensions are nominal dimensions which are subject to tolerances.

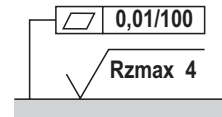

Required surface quality of the valve contact surface

- ① component side – porting pattern according to ISO 4401-03-02-0-05 and NFPA T3.5.1 R2-2002 D03 (with locating hole $\varnothing 4 \times 4$ mm deep; version "/60" or without locating hole)
- ② plate side – porting pattern according to ISO 4401-03-02-0-05 and NFPA T3.5.1 R2-2002 D03 (with locating hole $\varnothing 3 \times 5$ mm deep for locking pin ISO 8752-3x8-St; version "/60" or without locating hole)

- 11 For all adjustment types:
Left rotation = higher flow
Right rotation = lower flow
- 12 Modification from supply to discharge throttling is realized by rotation of the device around axis "X" – "X"
- 13 Stroke
- 14 Plug screw SW22

- 1 Name plate
- 2 Adjustment type "2"
- 3 Adjustment type "3"
- 4 Adjustment type "5"
- 5 Space required to remove the key
- 6 Valve mounting bores
- 7 Lock nut SW10
- 8 Setscrew/spindle for flow cross-section adjustment (internal hexagonal SW5)
- 9 Identical seal rings for ports A, B, P, and T
- 10 Seal ring plate

Valve mounting screws (separate order)

4 hexagon socket head cap screws

ISO 4762 - M5 - 10.9

4 hexagon socket head cap screws

N10-24 UNC ASTM - A574

Notes:

- ▶ Length and tightening torque of the valve mounting screws must be calculated according to the components mounted under and over the sandwich plate valve.
- ▶ The dimensions are nominal dimensions which are subject to tolerances.

Accessories (separate order)

Denomination	Material no.
Protective cap	R900692658
Locking pin	R90005694

Further information

- ▶ Hydraulic fluids on mineral oil basis
- ▶ Environmentally compatible hydraulic fluids
- ▶ Flame-resistant, water-free hydraulic fluids
- ▶ Flame-resistant hydraulic fluids - containing water (HFAE, HFAS, HFB, HFC)
- ▶ Hydraulic valves for industrial applications

- ▶ Use of non-electrical hydraulic components in explosive atmospheres (ATEX)
- ▶ Selection of filters
- ▶ Information on available spare parts

Data sheet 90220

Data sheet 90221

Data sheet 90222

Data sheet 90223

Operating instructions 07600-B

Data sheet 07011

www.boschrexroth.com/filterwww.boschrexroth.com/spc

Bosch Rexroth AG
 Industrial Hydraulics
 Zum Eisengießer 1
 97816 Lohr am Main, Germany
 Phone +49 (0) 93 52/40 30 20
my.support@boschrexroth.de
www.boschrexroth.de

© All rights reserved to Bosch Rexroth AG, also regarding any disposal, exploitation, reproduction, editing, distribution, as well as in the event of applications for industrial property rights.
 The data specified above only serve to describe the product. No statements concerning a certain condition or suitability for a certain application can be derived from our information. The information given does not release the user from the obligation of own judgment and verification.
 It must be remembered that our products are subject to a natural process of wear and aging.