

# Check valve

## Type Z1S

**RE 21537**

Edition: 2015-06

Replaces: 09.10



H7647

- ▶ Size 10
- ▶ Component series 4X
- ▶ Maximum operating pressure 350 bar [5076 psi]
- ▶ Maximum flow 100 l/min [26.4 US gpm]

### Features

- ▶ Sandwich plate valve for use in vertical stackings
- ▶ Porting pattern according to ISO 4401-05-04-0-05, ISO 4401-05-05-0-05 and NFPA T3.5.1 R2-2002 D05
- ▶ Diverse blocking functions, one and two-channel
- ▶ Optimal leak-tightness thanks to high-performance plastic poppet
- ▶ Corrosion-resistant housing design, optional
- ▶ Suitable for different hydraulic fluids by simply exchanging the external seal rings (can be retrofitted)
- ▶ Cost-effective exchange of the wear parts as the check valve installation set can be ordered separately
- ▶ With measuring ports, optional
- ▶ Throttle check valve, optional

### Contents

Features	1
Ordering codes	2, 3
Symbols	4, 5
Function, section	5
Technical data	6
Characteristic curves	7
Dimensions	8
Notices	9
Troubleshooting	9
Check valve installation set: Disassembly and assembly	10
Further information	10

**Ordering codes**

01	02	03	04	05	06	07	08	09	10	11	12	13	14	15	16	17	18	19			
<b>Z1S</b>	<b>10</b>			-							-	<b>4X</b>	/	<b>F</b>	/				-		*

01	Check valve, sandwich plate	<b>Z1S</b>
----	-----------------------------	------------

02	Size 10	<b>10</b>
----	---------	-----------

**Check valve 1**<sup>1)</sup> – in channel ...

03	Channel A	<b>A</b>
	Channel B	<b>B</b>
	Channel P	<b>P</b>
	Channel TA	<b>TA</b>
	Channel TB	<b>TB</b>

**Check valve 1**<sup>1)</sup> – cracking pressure

04	without spring	<b>00</b>
	0.5 bar [7.25 psi]	<b>05</b>
	3.0 bar [43.51 psi]	<b>30</b>
	5.0 bar [72.52 psi]	<b>50</b>

**Check valve 1**<sup>1)</sup> – installation direction

05	Component side ① (direction of flow ② → ①)	<b>1</b>
	Plate side ② (direction of flow ① → ②)	<b>2</b>

**Check valve 1**<sup>1)</sup> – nozzle diameter (when used as a throttle check valve)

06	Without throttle	<b>no code</b>
	Ø0.5 mm [0.0197 inch]	<b>D05</b>
	Ø1.0 mm [0.0394 inch]	<b>D10</b>
	Ø1.5 mm [0.0591 inch]	<b>D15</b>

**Check valve 2 (optional)**<sup>1)</sup> – in channel ...

07	Without check valve 2	<b>no code</b>
	Channel B	<b>B</b>
	Channel P	<b>P</b>
	Channel TA	<b>TA</b>
	Channel TB	<b>TB</b>

**Check valve 2 (optional)**<sup>1)</sup> – cracking pressure

08	Without check valve 2	<b>no code</b>
	Without spring	<b>00</b>
	0.5 bar [7.25 psi]	<b>05</b>
	3.0 bar [43.51 psi]	<b>30</b>
	5.0 bar [72.52 psi]	<b>50</b>

**Check valve 2 (optional)**<sup>1)</sup> – installation direction

09	Without check valve 2	<b>no code</b>
	Component side ① (direction of flow ② → ①)	<b>1</b>
	Plate side ② (direction of flow ① → ②)	<b>2</b>

**Check valve 2 (optional)**<sup>1)</sup> – nozzle diameter (when used as a throttle check valve)

10	without throttle	<b>no code</b>
	Ø0.5 mm [0.0197 inch]	<b>D05</b>
	Ø1.0 mm [0.0394 inch]	<b>D10</b>
	Ø1.5 mm [0.0591 inch]	<b>D15</b>

**Ordering codes**

01	02	03	04	05	06	07	08	09	10	11	12	13	14	15	16	17	18	19			
<b>Z1S</b>	<b>10</b>			-							-	<b>4X</b>	/	<b>F</b>	/				-		*

11	Channels TA and TB free-flowing	<b>no code</b>
	Channel TA closed	<b>TA9</b>
	Channel TB closed	<b>TB9</b>
12	Component series 40 ... 49 (40 ... 49: unchanged installation and connection dimensions)	<b>4X</b>

**Seal material**

13	FKM seals	<b>F</b>
	Observe compatibility of seals with hydraulic fluid used. (Other seals upon request)	

**Additional pilot oil ports X and Y**

14	Without X and Y	<b>no code</b>
	With X and Y	<b>XY</b>

**Measuring port G1/4**

15	Without measuring port	<b>no code</b>
	In channel A	<b>MA</b>
	In channel B	<b>MB</b>
	In channel P	<b>MP</b>
	In channel TA	<b>MTA</b>
16	Without measuring port	<b>no code</b>
	Measuring port input	<b>A</b>
	Measuring port output	<b>B</b>

**Corrosion resistance** (external; thick film passivated (DIN 50979 Fe//Zn8//Cn//T0))

17	None (valve housing primed)	<b>no code</b>
	Improved corrosion protection (240 h salt spray test according to EN ISO 9227)	<b>J3</b>

**Special version**<sup>2)</sup>

18	Measuring port in P (G1/2)	<b>068</b>
	With tank bracket	<b>120</b>
19	Further details in the plain text	<b>*</b>

1) Symbols (examples) see page 4

2) Symbols see page 5

**Symbols** (1) = component side, (2) = plate side)

Type Z1S 10 **A**.-1-4X/...  
(check valve in channel A)

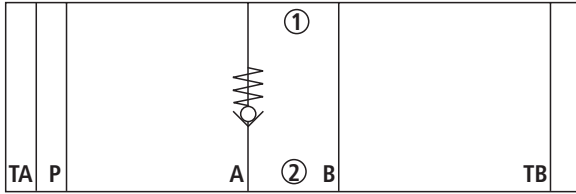

Type Z1S 10 **B**.-2-4X/... (check valve in channel B)

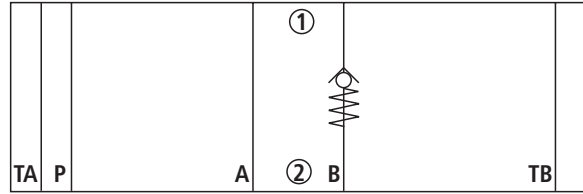

Type Z1S 10 **A**.-2B.-2-4X/...  
(check valve in channel A and B)

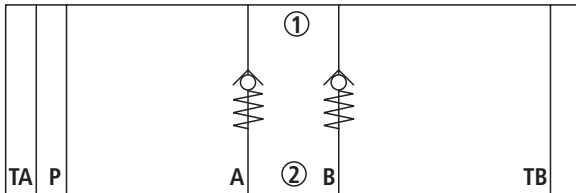

Type Z1S 10 **TA**.-2-**TB9**-4X/...  
(check valve in channel TA, TB locked)

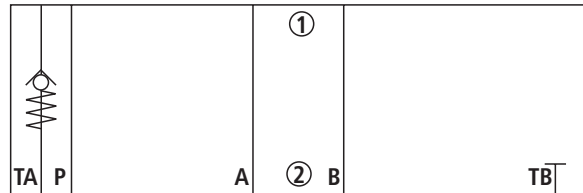

Type Z1S 10 **A**.-2D10-4X/...  
(check valve in channel A with nozzle Ø1.0 mm)

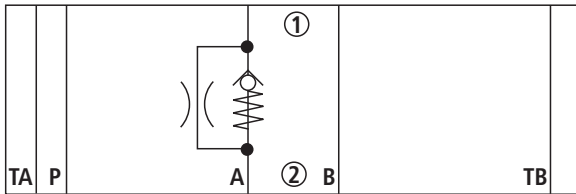

Type Z1S 10 **P**.-1**TA**-2**TB9**-4X/...  
(check valve in channel TA and P, TB locked)

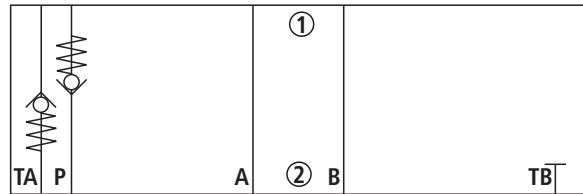

Type Z1S 10 **TA**.-2**TB**-2-4X/...  
(check valve in channel TA and TB)

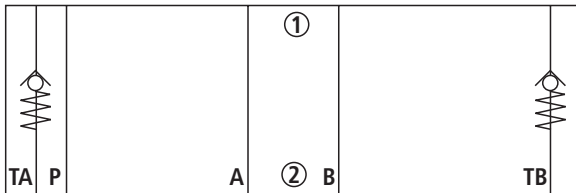

Type Z1S 10 **P**.-1-4X/F/**XY**...  
(check valve in channel P, additionally channel X and Y)

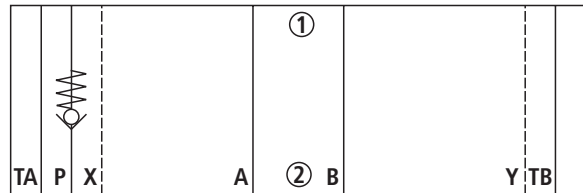

Type Z1S 10 **P**.-1-4X/F/**MPB**...  
(check valve in channel P, measuring port P Out G1/4)

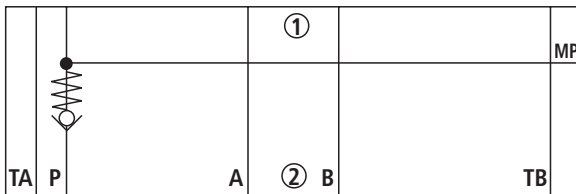

Type Z1S 10 **TA**.-2-**TB9**-4X/...  
(check valve in channel TA, TB locked)

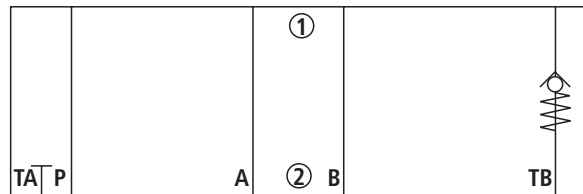

**Symbols:** Special versions (① = component side, ② = plate side)

Type Z1S 10 P.-1-4X/...-068  
(check valve in channel P, measuring port in P (G1/2))

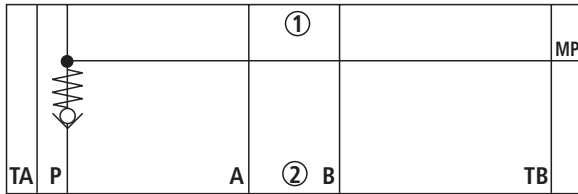

Type Z1S 10 TA.-2-TB9-4X/...-120  
(check valve in channel TA, with tank bracket)

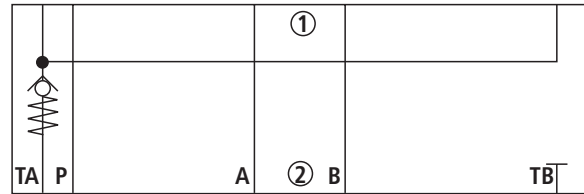

### Function, section

The type Z1S valve is a direct-operated sandwich plate check valve.

It blocks flow in one direction without leakage, while allowing free flow in the opposite direction.

The stroke of the plastic poppet (1) is limited by the plastic socket (2). The installed spring (3) supports the closing movement. If the valve is not flown through, the spring (3) holds the plastic poppet (1) in closed position. Perfect leak-tightness is already achieved with low pressures ( $0.1 \times p_{max}$ ).

**Note:**

In all installation positions, in which the plastic socket (2) is mounted on the plate side ②, no additional seal ring must be used in this position! On the component side ①, sealing is (as usual) ensured by the seal ring of the subsequently mounted assembly.

The installed plastic socket (2) has a sealing function and must therefore not be removed or damaged.

The protrusion of the plastic socket (2) is necessary for design reasons (preload).

Depending on the included hydraulic fluid volume and its temperature variations, static pressure changes may result that are not attributable to leakage at the seat area.

**Example:**

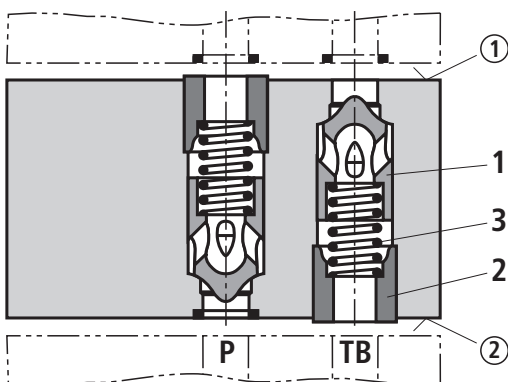

Type Z1S 10 P.-1.TB.-2-4X/...

- ① = component side
- ② = plate side

**Technical data**

(For applications outside these parameters, please consult us!)

General		
Mass	kg [lbs]	about 2.3 [5.1]
Installation position		any
Ambient temperature range	°C [°F]	-20 ... +80 [-4... +176]

Hydraulics		
Maximum operating pressure	bar [psi]	350 [5076]
Cracking pressure	bar [psi]	0.5; 3; 5 [7.25; 43.51; 72.52]
Max. flow	l/min [US gpm]	100 [26.4]
Hydraulic fluid		see table below
Hydraulic fluid temperature range (at the valve working ports)	°C [°F]	-20 ... +80 [-4... +176]
Viscosity range	mm <sup>2</sup> /s [SUS]	2.8 ... 500 [35 ... 2320]
Maximum admissible degree of contamination of the hydraulic fluid Cleanliness class according to ISO 4406 (c)		Class 20/18/15 <sup>1)</sup>

Hydraulic fluid	Classification	Suitable sealing materials	Standards	Data sheet
Mineral base oils	HL, HLP, HLPD, HVLP, HVLPD	NBR, FKM	DIN 51524	90220
Bio-degradable	▶ Insoluble in water	HETG	ISO 15380	90221
		HEES		
	▶ Soluble in water	HEPG	ISO 15380	
Flame-resistant	▶ Water-free	HFDU, HFDR	ISO 12922	90222
	▶ Containing water	HFC (Fuchs Hydrotherm 46M, Petrofer Ultra Safe 620)	ISO 12922	90223

**Important information on hydraulic fluids:**

- ▶ For more information and data about the use of other hydraulic fluids, refer to data sheets above or contact us!
- ▶ There may be limitations regarding the technical valve data (temperature, pressure range, life cycle, maintenance intervals, etc.).
- ▶ The flash point of the hydraulic fluid used must be 40 K higher than the maximum solenoid surface temperature.

**▶ Flame-resistant – containing water:**

- Maximum pressure differential per control edge 50 bar
- Pressure pre-loading at the tank port >20 % of the pressure differential, otherwise increased cavitation
- Life cycle as compared to operation with mineral oil HL, HLP 50 to 100 %

- ▶ **Bio-degradable and flame-resistant:** When using these hydraulic fluids that are simultaneously zinc-solvent, zinc may accumulate (700 mg zinc per pole tube).

<sup>1)</sup> The cleanliness classes specified for the components must be adhered to in hydraulic systems. Effective filtration prevents faults and at the same time increases the life cycle of the components. For the selection of the filters see [www.boschrexroth.com/filter](http://www.boschrexroth.com/filter).

## Characteristic curves

(measured with HLP46,  $\vartheta_{oil} = 40 \pm 5 \text{ }^\circ\text{C}$  [ $104 \pm 9 \text{ }^\circ\text{F}$ ])

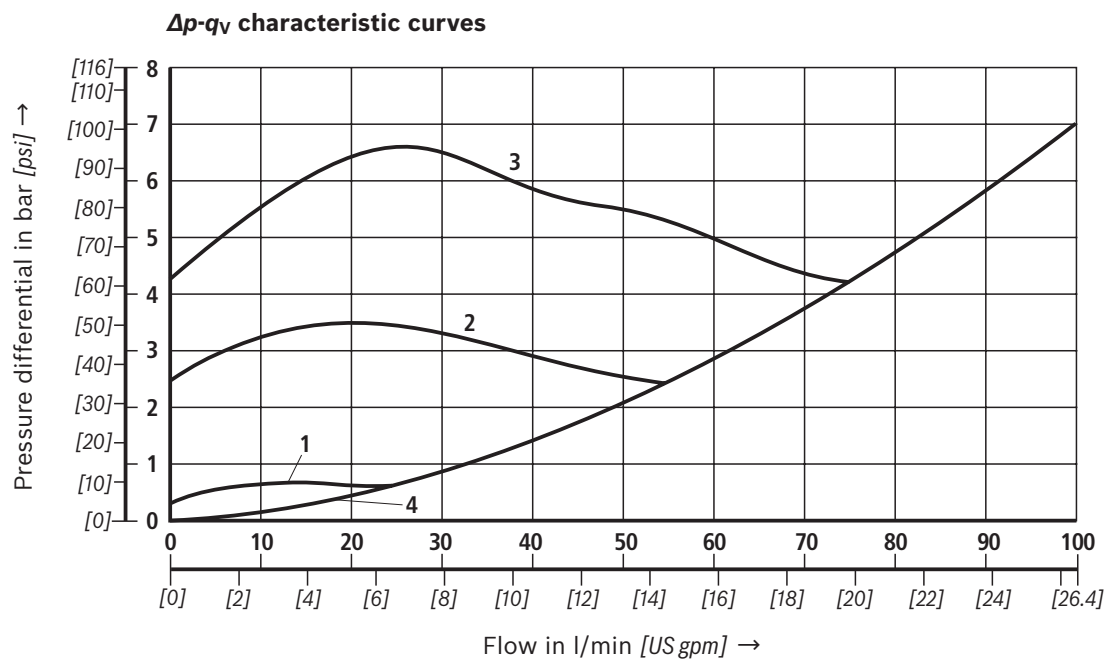

- 1 Cracking pressure 0.5 bar [7.25 psi]
- 2 Cracking pressure 3.0 bar [43.51 psi]
- 3 Cracking pressure 5.0 bar [72.52 psi]
- 4 Without check valve

## Dimensions

(in mm [inch])

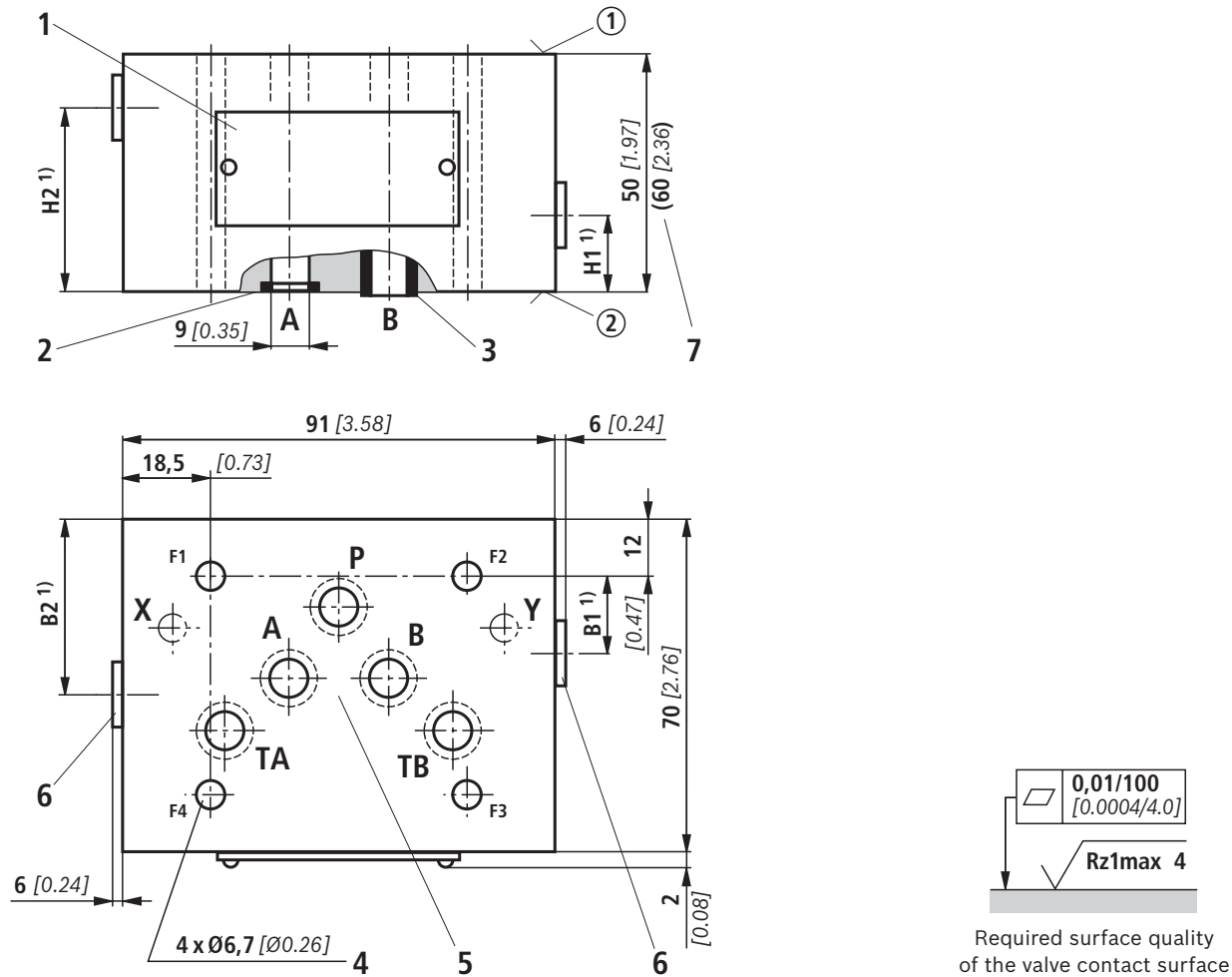

Required surface quality of the valve contact surface

- 1 Name plate
- 2 Identical seal rings for ports A, B, P, TA, and TB; identical seal rings for ports X and Y (plate side)
- 3 Plastic socket (position and quantity depend on order option)
- 4 Valve mounting bores
- 5 Porting pattern according to ISO 4401-05-04-0-05, ISO 4401-05-05-0-05 and NFPA T3.5.1 R2-2002 D05
- 6 Plug screw for measuring port (position and quantity depend on order option)
  - ▶ Connection G1/4:  
Tightening torque  $M_A = 30 \text{ Nm}$  [22.1 ft-lbs] +10 %
  - ▶ Port G1/2 ("068" version):  
Tightening torque  $M_A = 80 \text{ Nm}$  [59 ft-lbs] +10 %
- 7 Dimension with model "120"

**Valve mounting screws** (separate order)

**4 hexagon socket head cap screws ISO 4762 - M6 - 10.9**

**4 hexagon socket head cap screws 1/4-20 UNC**

### Note:

The length of the valve mounting screws of the sandwich plate valve must be selected according to the components mounted under and over the isolator valve. Depending on the application, screw type and tightening torque must be adjusted to the circumstances. Please ask Rexroth for screws with the required length.

① = component side

② = plate side

1) On request (depending on the order option)



## Notices

- ▶ Valve housing (steel) and plastic spool with plastic socket can be dismantled into individual parts for proper disposal.
- ▶ Deviating from ISO 4401, port T is in this data sheet called TA, port T1 is called TB.
- ▶ The check valve installation set is separately available (plastic socket, plastic spool, spring):  
Email: spareparts.bri@boschrexroth.de
- ▶ The plastic socket has a sealing function and must therefore not be damaged!
- ▶ For assembly and disassembly of the check valve installation set, a special multi-purpose tool has to be used, see page 10.

## Troubleshooting

External leakage at the flow passages	Seal ring defective.	Replace seal rings (seal kit).
	Lip of the plastic socket is damaged.	Replace the check valve installation set. <sup>1)</sup>
	The mounting screws have been tightened unevenly.	Loosen the screws and re-tighten them crosswise, applying the recommended tightening torque.
Internal leakage at the check valve installation set	Foreign particles on poppet surface.	From the outside, check poppet surface for foreign particles and remove them, if necessary.
	Poppet not freely moving.	Check freedom of movement of the poppet from the outside using a suitable mandrel. Attention - don't push the plastic socket out of the housing!
	Leakage due to downstream assembly.	Find out whether the check valve installation set is the cause of the leakage.
	Hydraulic fluid quality does not comply with the specification.	Check the hydraulic fluid quality and ensure compliance with the specification.
	Depending on the included hydraulic fluid volume and its temperature variations, pressure changes may occur that are not attributable to leakage.	
	The measures described above have not been successful:	Completely replace the check valve installation set. <sup>1)</sup>
External leakage at measuring points	Seal is defective.	Replace the profile seal.
	Plug screw or fitting has not been tightened correctly.	Tighten the plug screw or fitting with the specified tightening torque.

<sup>1)</sup> Use special multi-purpose tool in order to prevent damage at the plastic socket, see page 10.

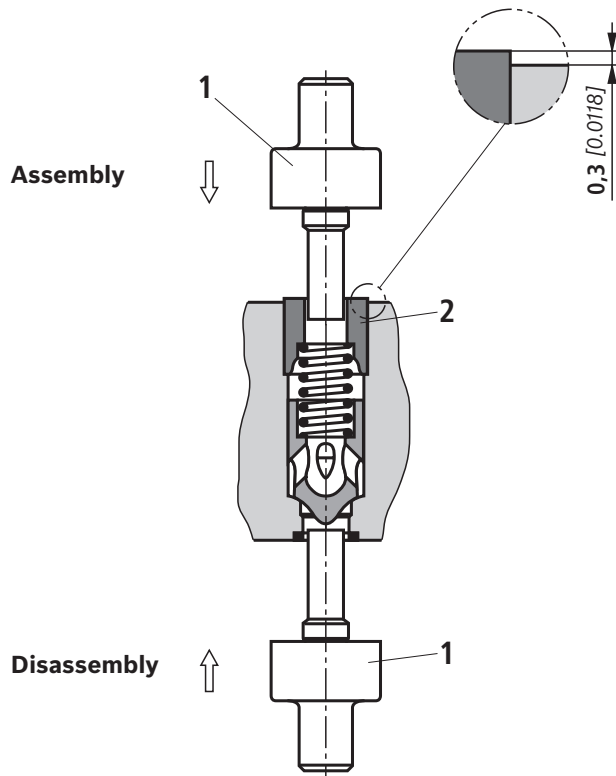
**Check valve installation set: Disassembly and assembly**

Disassembly/assembly without any damage is ensured by using the special multi-purpose tool (1) (material no. **R901182853**, ordered separately).

**Disassembly:**

Press out the check valve installation set.

**Assembly:**

Insert the check valve installation set and press the plastic socket (2) in.

In case of correct assembly by using the special multi-purpose tool (1), the protrusion of the plastic socket (2) is about 0.3 mm [0.0118 inch].

**Note:**

Disassembled plastic sockets must not be re-used.

**Further information**

- ▶ Sandwich plates size NG10
- ▶ Manifolds
- ▶ Mineral-oil-based hydraulic fluids
- ▶ Environmentally compatible hydraulic fluids
- ▶ Flame-resistant, water-free hydraulic fluids
- ▶ Flame-resistant hydraulic fluids - containing water (HFAE, HFAS, HFB, HFC)
- ▶ Reliability characteristics according to EN ISO 13849
- ▶ Hexagon socket head cap screws metric/UNC
- ▶ Hydraulic valves for industrial applications
- ▶ General product information on hydraulic products
- ▶ Assembly, commissioning and maintenance of industrial valves
- ▶ Selection of the filters

Data sheet 48052

Data sheet 48107

Data sheet 90220

Data sheet 90221

Data sheet 90222

Data sheet 90223

Data sheet 08012

Data sheet 08936

Operating instructions 07600-B

Data sheet 07008

Data sheet 07300

[www.boschrexroth.com/filter](http://www.boschrexroth.com/filter)

Bosch Rexroth AG  
Hydraulics  
Zum Eisengiesser 1  
97816 Lohr am Main, Germany  
Phone: +49 (0) 93 52/18-0  
[documentation@boschrexroth.de](mailto:documentation@boschrexroth.de)  
[www.boschrexroth.de](http://www.boschrexroth.de)

© All rights reserved by Bosch Rexroth AG, as well as in the case of registration of industrial property rights. It may not be reproduced or given to third parties without the consent of Bosch Rexroth AG.

The data specified above only serve to describe the product. No statements concerning a certain condition or suitability for a certain application can be derived from our information. This information also does not release the user from exercising his/her own judgment and conducting his/her own testing. Our products are subject to a natural process of wear and aging.

## Notes

Bosch Rexroth AG  
Hydraulics  
Zum Eisengiesser 1  
97816 Lohr am Main, Germany  
Phone: +49 (0) 93 52 / 18-0  
documentation@boschrexroth.de  
www.boschrexroth.de

© All rights reserved by Bosch Rexroth AG, as well as in the case of registration of industrial property rights. It may not be reproduced or given to third parties without the consent of Bosch Rexroth AG.

The data specified above only serve to describe the product. No statements concerning a certain condition or suitability for a certain application can be derived from our information. This information also does not release the user from exercising his/her own judgment and conducting his/her own testing. Our products are subject to a natural process of wear and aging.

## Notes

Bosch Rexroth AG  
Hydraulics  
Zum Eisengiesser 1  
97816 Lohr am Main, Germany  
Phone: +49 (0) 93 52 / 18-0  
documentation@boschrexroth.de  
www.boschrexroth.de

© All rights reserved by Bosch Rexroth AG, as well as in the case of registration of industrial property rights. It may not be reproduced or given to third parties without the consent of Bosch Rexroth AG.  
The data specified above only serve to describe the product. No statements concerning a certain condition or suitability for a certain application can be derived from our information. This information also does not release the user from exercising his/her own judgment and conducting his/her own testing. Our products are subject to a natural process of wear and aging.