

Maintenance Indicators

1. Features

Filter elements are economically used only if their dirt holding capacity is fully exploited. This is achieved by using filter housings with a maintenance indicator.

MAHLE manufactures maintenance indicators of the following designs:

- Differential pressure indicators
- Pressure indicators/switches/gauges
- Vacuum switches/gauges

With any filter element the collection of dirt particles continuously reduces the number of open pores or, in other words: The open cross section for allowing the liquid to flow is continuously reduced. Thus the pressure on the upstream side of the element (dirt side) increases continuously.

With pressure filters, the pressure is measured upstream and downstream of the filter element (differential pressure). With return line filters the pressure is measured only on the upstream side because, depending on the tank design, atmospheric pressure exits on the downstream side of the filter element is measured analog. With suction filters the vacuum is measured downstream.

A piston with attached magnet is moved against the force of a spring, with which the indicating point is determined by the piston surface. A homopolar poled magnet is fitted in the outer part in the indicating button.

The closer the pole-springs move towards each other, the stronger is the force with the magnets mutually repel, until finally the red button on the indicator pops out.

This red button remains visible until it is pushed in during the daily check which is to be performed while the plant is at operating temperature. If the button pops out immediately after being pushed in, the filter element must be replaced latest at the end of the shift.

This optical function may also be used for generating contactless electrical signals. For this purpose an electrical upper part is pushed over the hydraulic/optical part. This upper part incorporates all electrical switching elements.

- Optical and electrical indicator with standard check function
- Normally open/normally closed combination - standard feature
- Electrical function, easy to install at a later time
- Two-step indication, at 75 % and 100 % optional
- Signal lock out up to approx. 30 °C optional
- Rugged, non-bypass design
- Optimal element exploitation
- Worldwide distribution



2. Differential pressure indicators

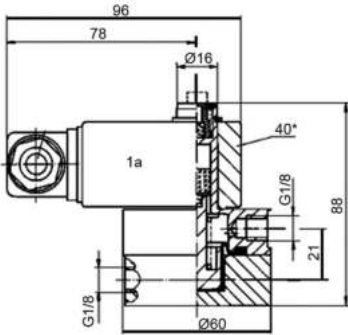

Fig. 1

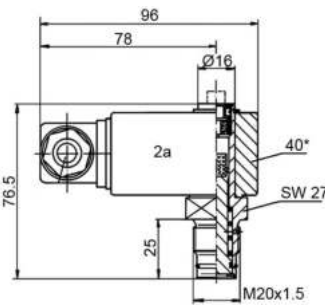

Fig. 2

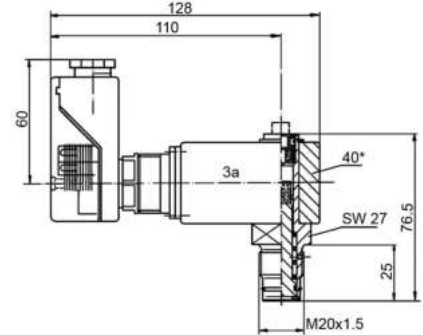

Fig. 3

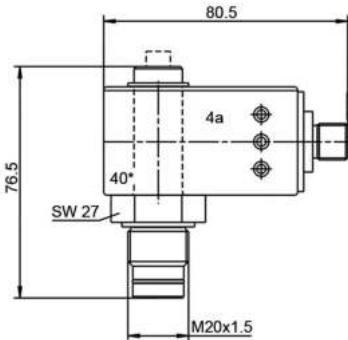

Fig. 4

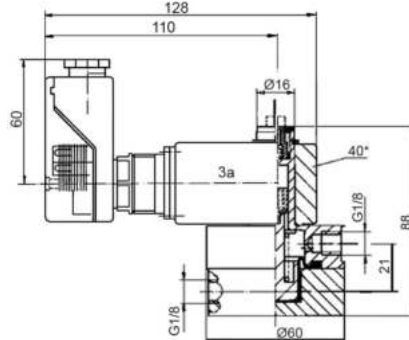

Fig. 15

40* = 40 mm wide

Differential pressure indicators

Nominal pressure [bar]	Temperature [°C]	Type	Order number	Indicator setting [bar]	Indication	Contact type*	Fig.	Material lower section	Material upper section
10	-10 - +120	PiS 3087	77738990	1.2	visual	-	1	Al	PA 6
		PiS 3086	77737513		visual/electr.	1	1 + 1a		
		PiS 3104	78236994		visual/electr.	4	1 + 3a (15)		
160	-10 - +120	PiS 3098	77669971	2.2	visual	-	2	Al	PA 6
		PiS 3097	77669948		visual/electr.	1	2 + 2a		
		PiS 3116	78308074		visual/electr.	3	2 + 2a		
		" " M12	79764028		visual/electr.	10	4 + 4a		
160	-10 - +120	PiS 3119	78309122	1.7/2.2	visual/electr.	2	2 + 2a	Al	PA 6
		PiS 3012	78308454		visual/electr.	4	3 + 3a		
		PiS 3131	79760869		visual/electr.	5	3 + 3a		
		PiS 3141	79761859		visual/electr.	6	3 + 3a		
		PiS 3151	79761909		visual/electr.	8	4 + 4a		
		PiS 3154	76300339		visual/electr.	9	4 + 4a		
		PiS 3157	76326706		visual/electr.	11	4 + 4a		
160	-10 - +120	PiS 3098	77938582	3.5	visual	-	2	Al	PA 6
		PiS 3097	78236648		visual/electr.	1	2 + 2a		
160	-10 - +120	PiS 3098	77669989	5.0	visual	-	2	Al	PA 6
		PiS 3097	77669955		visual/electr.	1	2 + 2a		
		PiS 3116	78308082		visual/electr.	3	2 + 2a		
160	-10 - +120	PiS 3119	78309130	3.7/5.0	visual/electr.	2	2 + 2a	Al	PA 6
		PiS 3012	78308447		visual/electr.	4	3 + 3a		
		PiS 3157	76326714		visual/electr.	11	4 + 4a		
		PiS 3131	79760877		visual/electr.	5	3 + 3a		
		PiS 3141	79761867		visual/electr.	6	3 + 3a		
		PiS 3151	79761917		visual/electr.	8	4 + 4a		
		PiS 3154	76300321		visual/electr.	9	4 + 4a		

Differential pressure indicators									
Nominal pressure [bar]	Temperature [°C]	Type	Order number	Indicator setting [bar]	Indication	Contact-type*	Fig.	Material lower section	Material upper section
400	-10 - +120	PiS 3093	77669898	2.2	visual	-	2	CuZn	PA 6
		PiS 3092	77669856		visual/electr.	1	2 + 2a		
		PiS 3115	78308041		visual/electr.	3	2 + 2a		
400	-10 - +120	PiS 3105	77970387	1.7/2.2	visual/electr.	2	2 + 2a	CuZn	PA 6
		PiS 3102	77942139		visual/electr.	4	3 + 3a		
		PiS 3132	79760919		visual/electr.	5	3 + 3a		
		PiS 3142	79761875		visual/electr.	6	3 + 3a		
		PiS 3152	79761925		visual/electr.	8	4 + 4a		
		PiS 3155	76300354		visual/electr.	9	4 + 4a		
		PiS 3158	76326722		visual/electr.	11	4 + 4a		
400	-10 - +120	PiS 3093	77669914	5.0	visual	-	2	CuZn	PA 6
		PiS 3092	77669864		visual/electr.	1	2 + 2a		
		PiS 3115	78308058		visual/electr.	3	2 + 2a		
		PiS 3115 M12	79764010		visual/electr.	10	4 + 4a		
400	-10 - +120	PiS 3105	77970395	3.7/5.0	visual/electr.	2	2 + 2a	CuZn	PA 6
		PiS 3102	77942147		visual/electr.	4	3 + 3a		
		PiS 3155	76300362		visual/electr.	9	4 + 4a		
		PiS 3132	79760919		visual/electr.	5	3 + 3a		
		PiS 3142	79761883		visual/electr.	6	3 + 3a		
		PiS 3152	79761933		visual/electr.	8	4 + 4a		
		PiS 3158	76326730		visual/electr.	11	4 + 4a		
400	-10 - +120	PiS 3093	77669880	8	visual	-	2	CuZn	PA 6
		PiS 3092	77669872		visual/electr.	1	2 + 2a		
		PiS 3115	78308066		visual/electr.	3	2 + 2a		
450	-10 - +120	PiS 3193	77844061	2.2	visual	-	2	1.4301	PA 6
		PiS 3192	78308488		visual/electr.	1	2 + 2a		
		PiS 3110	79353574		visual/electr.	7	3 + 3a		
450	-10 - +120	PiS 3193	78308538	5.0	visual	-	2	1.4301	PA 6
		PiS 3192	78308546		visual/electr.	1	2 + 2a		
		PiS 3110	79353582		electrical	7	3 + 3a		

*Contact type

- 1 Normally open/normally closed; 1 setting point; wiring box DIN EN 175301-803; max. 250 V AC/200 V DC; max. 1 A
- 2 Normally closed; 2 setting points; wiring box DIN EN 175301-803; max. 150 V; max. 1 A
- 3 Change-over contact; 1 setting point; wiring box DIN EN 175301-803; max. 150 V; max. 1 A
- 4 Change-over contact; 2 setting points; LED; Mercedes Benz Norm DBL 9666 EA; wiring box DIN EN 175201-804; max. 10-30 V; max. 1 A
- 5 Change-over contact; 2 setting points; LED; signal suppression; time delay; wiring box DIN EN 175201-804; 10-30 V; max. 1 A
- 6 Change-over contact; 2 setting points; LED; signal suppression; wiring box DIN EN 175201-804, 10-30 V; max. 1 A
- 7 Analog signal 4-20 mA; 2 setting points; LED; signal cold start; wiring box DIN EN 175201-804; 24 V; max. 1 A
- 8 Normally open/normally closed; 2 setting points; LED; signal suppression; plug connection M12x1; 10-30 V; max. 1 A
- 9 Normally open/normally closed; 2 setting points; LED; plug connection M12x1; 10-30 V; max. 1 A
- 10 Change-over contact; 1 setting point; plug connection M12x1; 150 V; max. 1 A
- 11 Normally closed/normally closed; 2 setting points; LED; plug connection M12x1; 150 V; max. 1 A

3. Pressure indicators/pressure switches

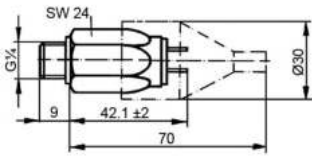

Fig. 5

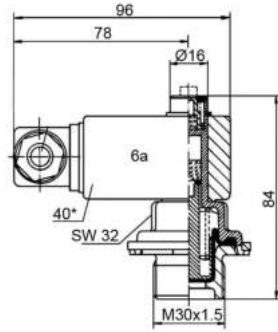

Fig. 6

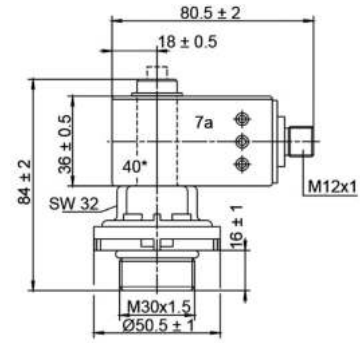

Fig. 7

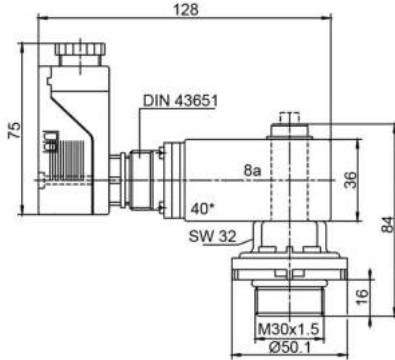

Fig. 8

40* = 40 mm wide

Pressure indicators/pressure switches									
Nominal pressure [bar]	Temperature [°C]	Type	Order number	Indicator setting [bar]	Indication	Contact type*	Fig.	Material lower section	Material upper section
10	-10 - +80	PiS 3084	77669781	1.2	visual	-	6	PA 66	PA 6
		PiS 3085	77669807		visual/electr.	1	6 + 6a		
		PiS 3125	78308033		visual/electr.	3	6 + 6a		
10	-10 - +80	PiS 3106	78309155	0.9/1.2	visual/electr.	2	6 + 6a	PA 66	PA 6
		PiS 3103	77942170		visual/electr.	4	8 + 8a		
10	-10 - +80	PiS 3084	77737802	2.2	visual	-	6	PA 66	PA 6
		PiS 3085	77738032		visual/electr.	1	6 + 6a		
		PiS 3125	78308108		visual/electr.	3	6 + 6a		
		PiS 3125 M12	79764747		visual/electr.	10	7 + 7a		
10	-10 - +80	PiS 3156	76300370	1.7/2.2	opt./elektr.	9	7 + 7a	PA 66	PA 6
		PiS 3159	76326748		visual/electr.	11	7 + 7a		
		PiS 3143	79761891		visual/electr.	6	8 + 8a		
		PiS 3153	79761941		visual/electr.	8	7 + 7a		
		PiS 3133	79760927		visual/electr.	5	6 + 3a		
		PiS 3106	78308850		visual/electr.	2	6 + 6a		
		PiS 3103	77970429		visual/electr.	4	8 + 8a		
10	-25 - +85	DSS/1.2	77863814	1.2	electrical	norm. open	5	galvanized steel	delivered with protection cap
		DSO/1.2	77870587		electrical	n. closed	5		
10	-25 - +85	DSS/2.2	77845845	2.2	electrical	norm. open	5		
		DSO/2.2	77870595		electrical	n. closed	5		
10	-25 - +85	DSS/5	77863822	5.0	electrical	norm. open	5		
		DSO/5	77870603		electrical	n. closed	5		

*Contact type see remarks below 2. Differential pressure indicators

4. Vacuum/pressure gauges

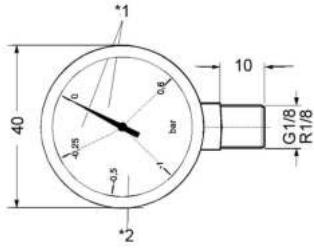

Fig. 9
*1 = Green area/*2 = Red area

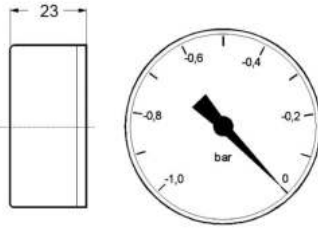

Fig. 10

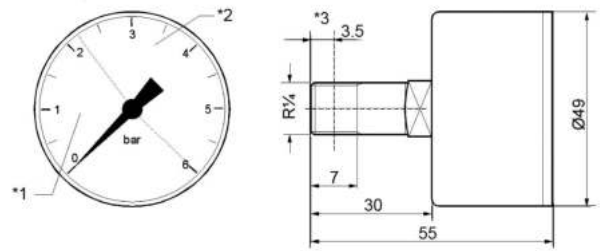

Fig. 11
*3 = Metering level

Vacuum/pressure gauges

Nominal size [NG]	Type	Order number	Indicating range [bar]	Connection size	Fig.	Class	Dial face
40	Vacuum gauge	76345763	-1 - +0.6	R1/8 conical	9	min. 2.5	Red/Green area sep. line -0.25 bar
		77545908		G1/8	9		white
50		77617558	-1 - 0	R1/4 conical	10		
50	Pressure gauge	78381998	0 - 6	R1/4 conical	11		Red/Green area sep. line 2.2 bar

5. Vacuum switches

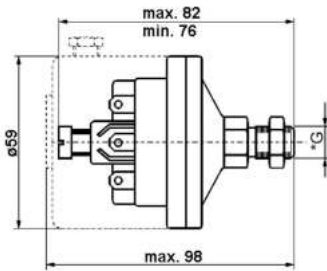

Fig. 12
*G = Connection

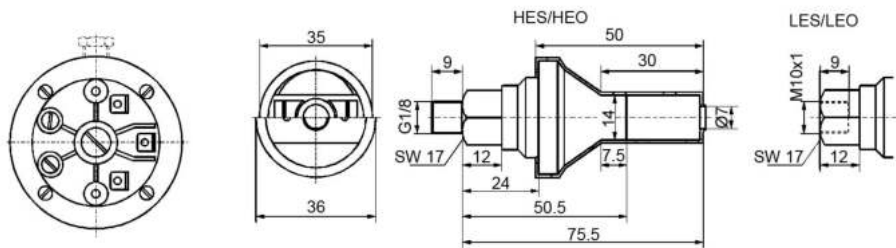

Fig. 13
HES/HEO only for fluids, LES/LEO only for air

Vacuum switches

Permissible over-pressure [bar]	Temperature [°C]	Type	Order number	Switch setting [mbar]	Contact type	Fig.	Connection *G	Material lower section	Material upper section
0.5	-10 - +70	PiS 3070	77669690	-15 - -80	single pole change-over switch, snap-in joint	12	G1/4	GD-Al	PA 6
1			77669724	-50 - -600			G1/8		
0.1	-20 - +80 short-term +120	HES 2200 BP	78308892	-200 ±10	normally open	13	G1/8 outside	GD-ZnAl	PC
		HEO 2200 BP	78308900		normally closed				
		LES 250 I	78308918	-50 ±4	normally open	M10x1 inside			
		LEO 250 I	78308926		normally closed				

6. Vacuum indicators/air filters

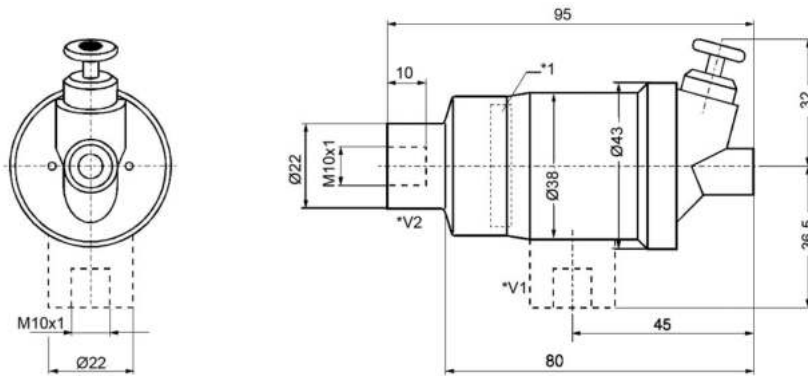

Fig. 14

*1 = Indication: position of display in mbar

*V1 = Version 1

*V2 = Version 2

Vacuum indicators/air filters

Temperature [°C]	Type	Order number	Indicator setting ±10 % [mbar]	Indication type	Fig.	Version
-40 - +110	TB 745	78309056	-50	optical self locking	14	1
	TB 745/1	78309064	-50			2
	TB 746/1	78309049	-65			2

7. Accessories

7.1 Seal kits

Type	NBR	FPM	EPDM
	Order number		
PiS 3092, 3093, 3102, 3105, 3115, 3132, 3142, 3152, 3155, 3192, 3193, 3158	77760275	77760283	77760291
PiS 3012, 3097, 3098, 3116, 3119, 3131, 3141, 3151, 3154, 3157	77760309	77760317	77760325
PiS 3084, 3085, 3103, 3106, 3125, 3133, 3143, 3153, 3156, 3159	78383382	78383390	78383408
PiS 3086, 3087, 3104	77760242	77760259	-

7.2 Electrical expansion kit/spare parts

Designation	Order number
Electrical upper section normally open/closed for PiS 3084, 3087, 3093, 3098, 3193 (contact type 1)	77536550
Wiring box with lamp insert 12 - 230 V for electrical upper section normally open (acc. to DIN EN 175301-803)	78307548
Electrical upper section change-over contact for PiS 3084, 3087, 3093, 3098, 3193 (contact type 3)	78308017
Wiring box with 2 LEDs 10 - 30 V for electrical upper section change over contact (acc. to DIN EN 175301-803)	78308025

Designation	Order number
Electrical upper section change-over contact M12x1 für PiS 3084, 3087, 3093, 3098, 3193 (contact type 10)	79764036
Electrical upper section 2SP-LED-M12x1-SU (contact type 8) spare part for 2 setting points indicator!	76116651
Electrical upper section 2SP-LED-M12x1 (contact type 9) spare part for 2 setting points indicator!	76300412
Electrical upper section W-2SP-LED-SU-VERZ (contact type 5) spare part for 2 setting points indicator!	79760943
Electrical upper section W-2SP-LED-SU (contact type 6) spare part for 2 setting points indicator!	76118590
Electrical upper section W-2SP/Ö-LED-M12x1 (contact type 11) spare part for 2 setting points indicator!	76326755
Electrical upper section normally closed with signal suppression PiS 3003	77765357
Electrical upper section normally open with signal suppression PiS 3002	77765365

7.3 Mounting block for differential pressure indicators (M20x1.5)

Designation	Order number
Mounting block (St)	77809098
Mounting block (1.4301), 450 bar	77698517

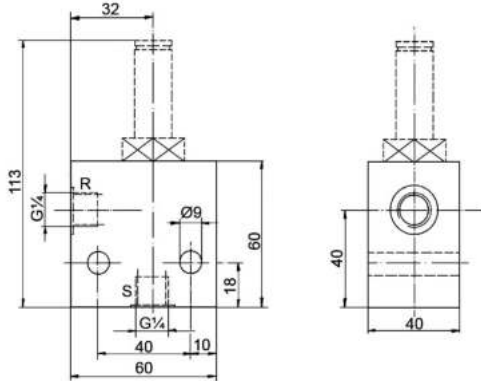

R = clean side
S = dirt side

7.4 Protection cap

Designation	Order number
Protection cap for all visual pressure and differential pressure indicators, -20 °C to +80 °C Resistant to: gasoil, purifying agent, insolation, dust, salt, water, concret	78285330

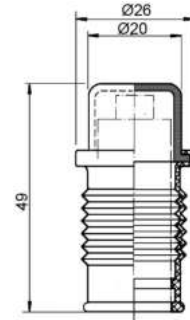

8. Function

The magnetic field as previously described, contactless operates reed contacts in the electrical upper part. The desired contact type is selected by inverting upper part. Another option keeping the electrical signal electronically suppressed up to 30 °C operating temperature is also available. This eliminates false electrical signal during the cold start phase.

For efficient servicing it is desirable to have a pre-warning device (so that the filter element can be replaced, e.g. with the next tool change). For this purpose electrical upper parts with two indicating points, i.e. at 75 % and at 100 % of the indicator setting are available.

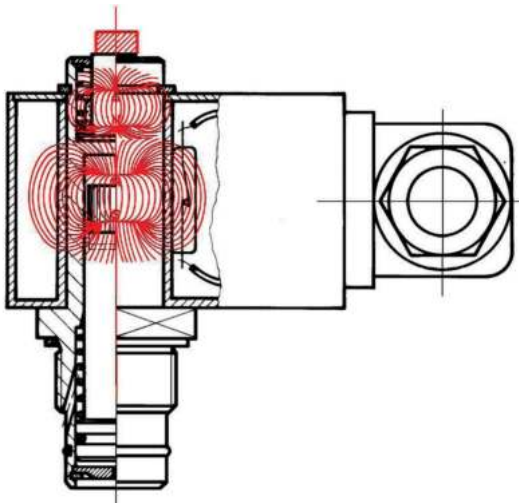

Pressure/vacuum gauges give an analog reading of the existing state of contamination of the filter elements. They require continuous control to ensure that the service time and reserve capacity are not unduly exceeded. If the contamination signal is disregarded, the filter element may collapse or, if a bypass valve is installed, part of the contamination fluid may reach the hydraulic components via the bypass valve and cause failure of the hydraulics.

Pressure/vacuum switches are provided with snap action switches, which ascertains that signal are issued only when the limit values have been fully reached.

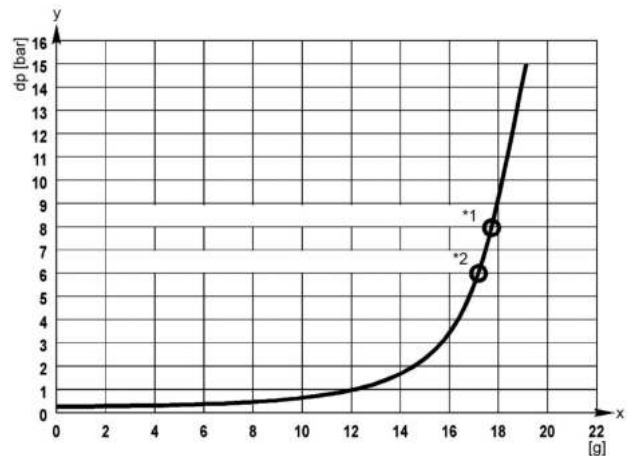

Dirt holding capacity - Δp curve

x = dirt holding capacity [g]

y = differential pressure Δp [bar]

*1 = signal step maintenance indicator 100 %

*2 = signal step maintenance indicator 75 %

9. Technical specifications

9.1 Contact type normally open/normally closed

Contact type 1

Types PiS 3085, 3086, 3092, 3097, 3192

Max. voltage: 250 V AC/ 200 V DC

Max. current: 1 A

Contact load: 70 W

Type of protection: IP 65 in inserted and secured status

Contact type : normally open/normally closed

Cable sleeve: M20x1.5

Wiring box: DIN EN 175 301-803

The switching function can be changed by turning the electric upper part by 180° (normally closed contact or normally open contact). The state on delivery is a normally closed contact.

By inductivity in the direct current circuit the use of suitable protection circuit should be considered. Electrical parts are insulated (plastic material housing).

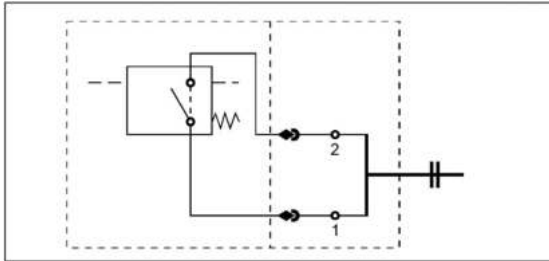

9.2 Contact type normally closed or open with signal suppression

Contact type normally closed

Type PiS 3003 (expansion kit)

Contact type normally open

Type PiS 3002 (expansion kit)

Signal suppression by thermorelay

Signal is released at +30 °C

for further technical details see 9.1

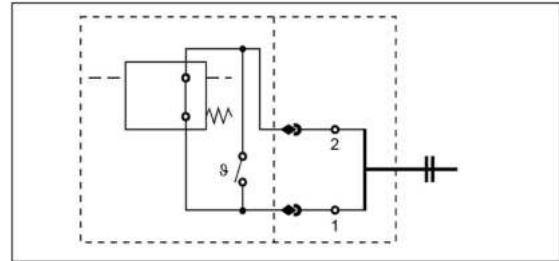

9.3 Contact type normally closed 2 setting points

Contact type 2

Types PiS 3105, 3106, 3119

1. setting point at 75 % of the indicating pressure

2. setting point at 100 % of the indicating pressure

Max. voltage: 150 V AC/DC

Max. current: 1 A

Contact load: 20 VA/20W

for further technical details see 9.1

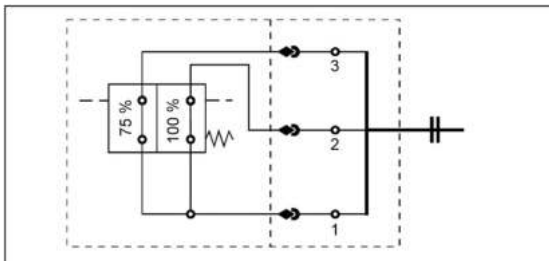

9.4 Contact type Change-over contact

Contact type 3

Types PiS 3115, 3116, 3125

Max. voltage: 150 V AC/DC

Max. current: 1 A

Contact load: 20 VA/20W

for further technical details see 9.1

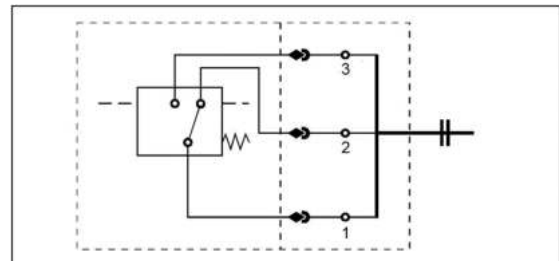

9.5 Contact type change-over contact, 2 setting points LED

Contact type 4

Types PiS 3012, 3102, 3103, 3104

1. setting point at 75 % of the indicating pressure
2. setting point at 100 % of the indicating pressure

Max. voltage: 10 - 30 V DC
 Max. current: 1 A
 Contact load: 20 VA/20 W
 Type of protection: IP 65 in inserted and secured status
 Plug connection: DIN EN 175201-804

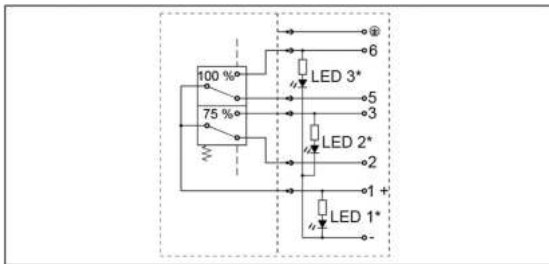

9.6 Wiring box with insert lamp

Will be supplied instead of standard connection.

Not to be combined with indicators with 2 setting points.

Max. voltage: 12-230 V AC/DC

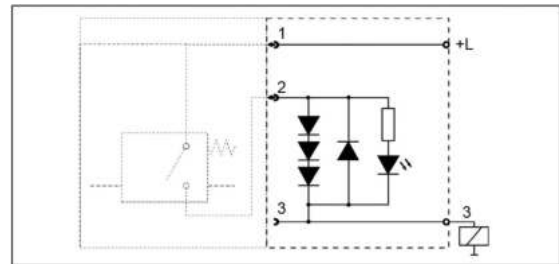

9.7 Contact type change-over contact, 2 setting points, LED, signal suppression, time delay

Contact type 5

Types PiS 3131, 3132, 3133

1. setting point at 75 % of the indicating pressure
2. setting point at 100 % of the indicating pressure

Max. voltage: 10 - 30 V DC
 Max. current: 1 A
 Contact load: 20 W
 Type of protection: IP 65 in inserted and secured status
 Plug connection: DIN EN 175201-804
 Signal suppression: by thermorelay
 Signal released: at + 30 °C
 Signal change down: at + 20 °C
 Impulse suppression K1 and K2 time delay 10 s

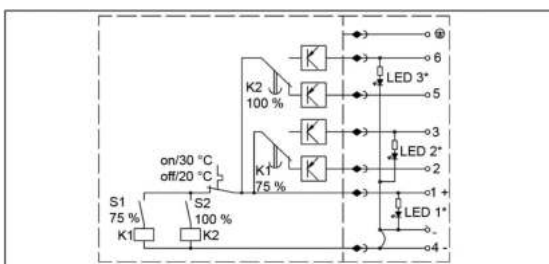

9.8 Contact type change-over contact, 2 setting points, LED, signal suppression

Contact type 6

Types PiS 3141, 3142, 3143

1. setting point at 75 % of the indicating pressure
2. setting point at 100 % of the indicating pressure

Max. voltage: 10 - 30 V DC
 Max. current: 1 A
 Contact load: 20 W
 Type of protection: IP 65 in inserted and secured status
 Plug connection: DIN EN 175201-804
 Signal suppression: by thermorelay
 Signal released: at + 30 °C
 Signal change down: at + 20 °C

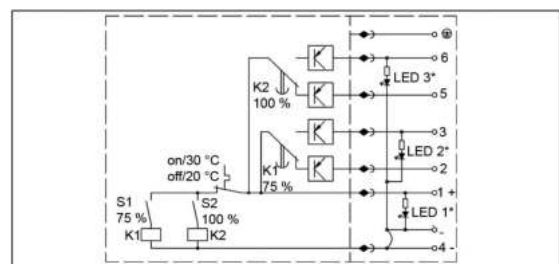

LED 1* = Operating LED green

LED 2* = Setting point 75 % LED yellow

LED 3* = Setting point 100 % LED red

9.9 Contact type analog 4-20 mA, 2 setting points, LED, signal suppression

Contact type 7

Types PiS 3110, 3120

Max. voltage:	24 V DC
Max. current:	200 mA
Resistance:	500 Ω
Type of protection:	IP 65 in inserted and secured status
Plug connection:	nach DIN EN 175201-804
Output signal:	4-20 mA
Outputs (PNP, max. 200 mA):	cold start signal 75 % setting point 100 % setting point
Signal damping:	20 s

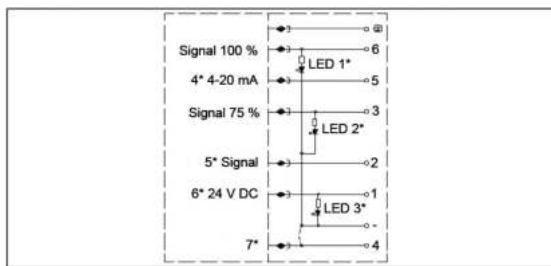

9.10 Contact type normally open/normally closed, 2 setting points, LED, signal suppression

Contact type 8

Types PiS 3151, 3152, 3153

1. setting point at 75 % of the indicating pressure (normally open)
2. setting point at 100 % of the indicating pressure (normally closed)

Max. voltage:	10 - 30 V DC
Max. current:	1 A
Contact load:	20 W
Type of protection:	IP 65 in inserted and secured status
Plug connection:	M12x1, 4 pole
Signal suppression:	by thermorelay
Signal release:	at + 30 °C
Signal change down:	at + 20 °C

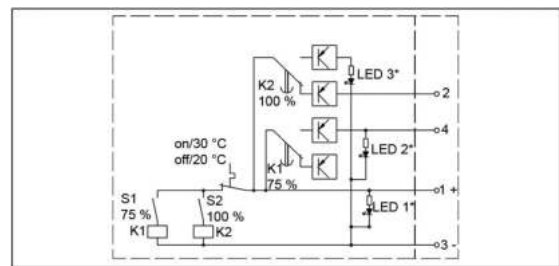

9.11 Contact type normally open/normally closed, 2 setting points

Contact type 9

PiS 3154, 3155, 3156

1. setting point at 75 % of the indicating pressure (normally open)
2. setting point at 100 % of the indicating pressure (normally closed)

Max. voltage:	10-30 V DC
Max. current:	1 A
Contact load:	20 W
Type of protection:	IP 65 in inserted and secured status
Plug connection:	M12x1, 4 pole

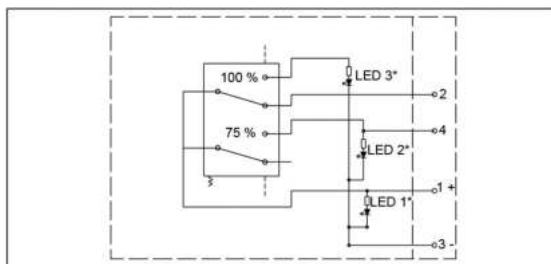

9.12 Contact type change-over contact

Contact type 10

PiS 3115-M12x1, 3116-M12x1, 3125-M12x1

Max. voltage:	150 V
Max. current:	1 A
Contact load:	20 W
Type of protection:	IP 65 in inserted and secured status
Plug connection:	M12x1, 4 pole

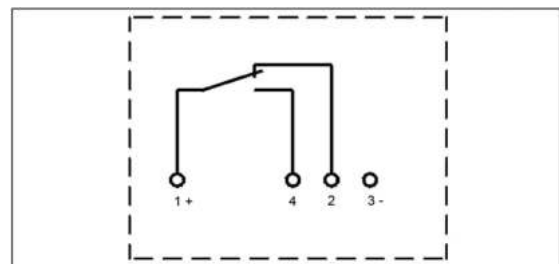

LED 1* = Operating LED green

LED 2* = Setting point 75 % LED yellow

LED 3* = Setting point 100 % LED red

9.13 Contact type normally closed, 2 setting points

Contact type 11

Types PiS 3157, 3158, 3159

1. setting point at 75 % of the indicating pressure (normally closed)
2. setting point at 100 % of the indicating pressure (normally closed)

Max. voltage: 10-30 V DC
 Max. current: 1 A
 Contact load: 20 W
 Type of protection: IP 65 in inserted and secured status
 Plug connection: M12x1, 4 pole

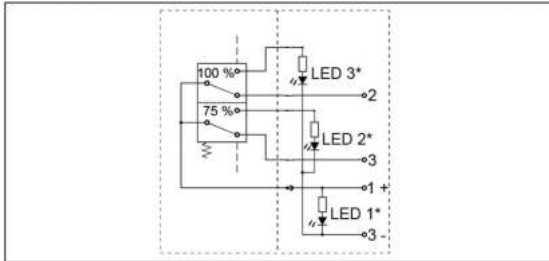

LED 1* = Operating LED green
 LED 2* = Setting point 75 % LED yellow
 LED 3* = Setting point 100 % LED red

9.15 Vacuum switch HEO/LEO

Contact type normally closed

Contact load HEO*: 42 V/6 W
 Contact load LEO*: 24 V/6 W

* at resistive load

for further technical details see 9.14

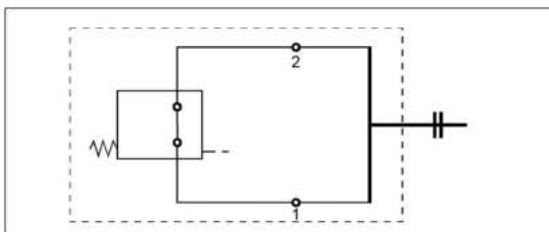

9.14 Vacuum switch HES/LES

Contact type normally open

Electrical connection: AMP 6,3 DIN 43248
 bushings DIN 46247
 switch type 2 pole
 Contact load HES*: 42 V/6 W
 Contact load LES*: 24 V/6 W
 Type of protection: IP 54 - with protecting cap

* at resistive load

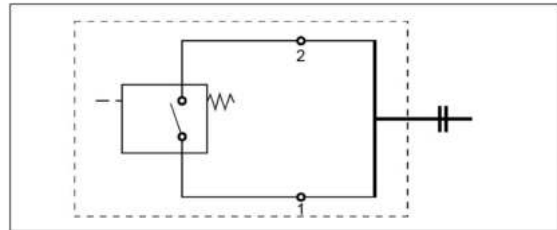

9.16 Vacuum switch PiS 3070

Contact type 1 pole change-over contact

Electrical connection: AMP 6,3 DIN 43248
 bushings DIN 46247
 Max. voltage: 230 V AC/DC
 Max. current: 6 A
 Type of protection: IP 00 without cover
 IP 54 with cover

Position of installation: individual (position of installation is to be advised if setting point is adjusted)

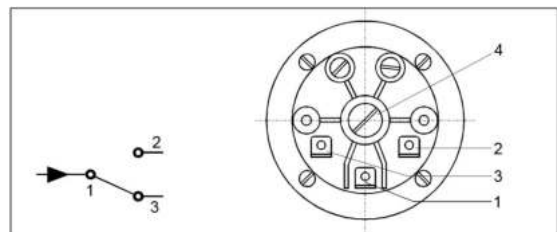

1 = Supply line
 2 = Operating contact

3 = Normally closed contact
 4 = Adjusting screw

9.17 Pressure switch DSS

Contact type	normally open
Electrical connection:	AMP 6,3 DIN 46248 bushings DIN 46247 switch type 2 pole
Max. voltage:	42 V
Max. current:	2 A
Contact load:	100 VA
Duty classification:	200/min

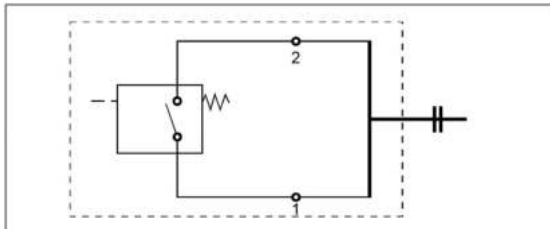

9.18 Pressure switch DSO

Contact type	normally closed
for further technical details see 9.17	

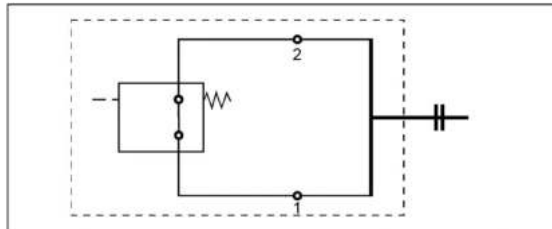

Maintenance indicators PiS 3084, 3087, 3093, 3098, 3193 can be mounted in 45°.

We draw attention to the fact that all values indicated are average values which do not always occur in specific cases of application: Our products are continually being further developed. Values, dimensions and weights can change as a result of this. Our specialized department will be pleased to offer you advice.

When using our filters in areas which are to be classified according to EU directive 94/9 EG (ATEX), we recommend prior discussion with us. The standard version can be used for liquids based on mineral oil /corresponding to the fluids in Group 2 of Directive 97/23 EG Article 9). Please consult with us if using other media.

Subject to technical alterations without prior notice.

MAHLE Industriefiltration GmbH
Schleifbachweg 45
74613 Öhringen
Phone +49 7941 67-0
Fax +49 7941 67-23429
industrialfiltration@mahle.com
www.mahle-industrialfiltration.com
78357428.06/2012