

Digital servoproportional directional valves

piloted, with on-board driver, two LVDT transducers and zero spool overlap

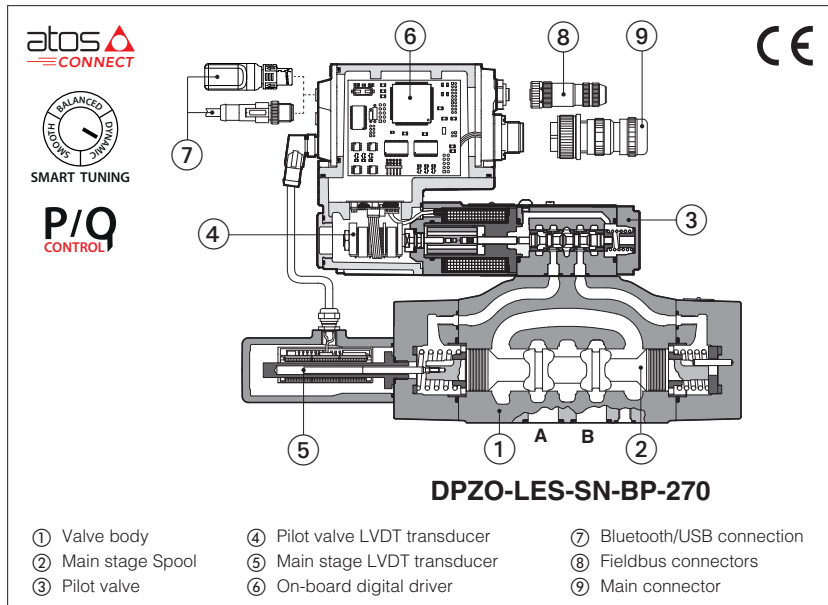

DPZO-LEB, DPZO-LES

Digital servoproportional directional valves, piloted, with two LVDT position transducer and zero spool overlap for position closed loop controls.

LEB basic execution with analog reference signal or IO-Link interface for digital reference signals, valve settings, and real-time diagnostics.

LES full execution which includes also optional alternated p/Q controls and fieldbus interfaces for digital reference signals, valve settings, and real-time diagnostics.

Bluetooth/USB connection is always present for valve settings via mobile App and Atos PC software.

Digital LEZ version (see tech. table FS630) integrates on-board driver and axis card, while LEB-SN-NP and LES versions can be used in combination with Z-BM-KZ off-board axis card (see tech. table GS340).

Size: **10 ÷ 35** - ISO 4401
 Max flow: **180 ÷ 3500 l/min**
 Max pressure: **350 bar**

1 MODEL CODE

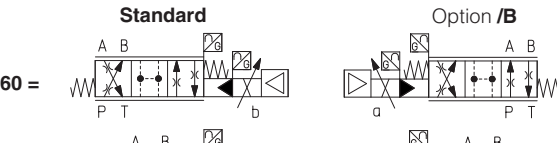
DPZO	-	LES	-	SN	-	NP	-	2		70	-	L		5	/	*	/	*	/	*	/	*			
Servoproportional directional valve, piloted		LEB = basic on-board digital driver LES = full on-board digital driver		SN = none Only for LES: SP = pressure control (1 pressure transducer) SF = force control (2 pressure transducers) SL = force control (1 load cell)		IO-Link interface , only for LEB, see section 6: NP = Not present IL = IO-Link		Fieldbus interfaces , only for LES, see section 7: NP = Not present EW = POWERLINK BC = CANopen EI = EtherNet/IP BP = PROFIBUS DP EP = PROFINET RT/IRT EH = EtherCAT		Valve size ISO 4401: 1 = 10 2 = 16 4 = 25 4M = 27 6 = 32 8 = 35		Configuration: 		Seals material , see section 14: - = NBR PE = FKM BT = NBR low temperature		Safety options TÜV certified - only for LES (2): U = safe double power supply K = safe on/off signals See section 10		Safety SAFETY CERTIFIED		Bluetooth option (2) , see section 4: T = Bluetooth adapter supplied with the valve		Hydraulic options (2): B = solenoid with on-board digital driver and LVDT transducer at side of port B of the main stage (side A of pilot valve) D = internal drain E = external pilot pressure G = pressure reducing valve for piloting (standard for DPZO-1)		Electronic options (2) , not available for LEB-SN-IL: C = current feedback for pressure transducer 4÷20mA (only LES-SP, SF, SL) F = fault signal I = current reference input and monitor 4÷20mA Q = enable signal Z = double power supply (only for LES), enable, fault and monitor signals - 12 pin connector	

Spool type, regulating characteristics, see section 15:

L = linear **T** = non linear (1) **DL** = differential-linear
 P-A = Q, B-T = Q/2
 P-B = Q/2, A-T = Q

Spool size:	3 (L)	5 (L,DL)	5 (L)	5 (T)
DPZO-1	= -	100	-	-
DPZO-2	= 160	250	-	190
DPZO-4	= -	480	-	-
DPZO-4M	= -	550	-	-
DPZO-6	= -	-	640	-
DPZO-8	= -	-	1200	-

Nominal flow (l/min) at Δp 10bar P-T (see section 12)

(1) Only for DPZO-*-270 (2) For possible combined options, see section 18

2 GENERAL NOTES

Atos digital proportionals valves are CE marked according to the applicable directives (e.g. Immunity and Emission EMC Directive). Installation, wirings and start-up procedures must be performed according to the general prescriptions shown in tech table **FS900** and in the user manuals included in the E-SW-SETUP programming software.

3 VALVE SETTINGS AND PROGRAMMING TOOLS - see tech. table **GS500**

3.1 Atos CONNECT mobile App

Free downloadable App for smartphones and tablets which allows quick access to valve main functional parameters and basic diagnostic information via Bluetooth, thus avoiding physical cable connection and significantly reducing commissioning time. Atos CONNECT supports Atos digital valve drivers equipped with E-A-BTH adapter or with built-in Bluetooth. It does not support valves with p/Q control or axis controls.



3.2 E-SW-SETUP PC software

Free downloadable software for PC allows to set all valve functional parameters and to access complete diagnostic information of digital valve drivers via Bluetooth/USB service port. Atos E-SW-SETUP PC software supports all Atos digital valve drivers and it is available at www.atos.com in MyAtos area.



WARNING: drivers USB port is not isolated! For E-C-SB-USB/M12 cable, the use of E-A-SB-USB/OPT isolator adapter is highly recommended for PC protection

Bluetooth or USB connection

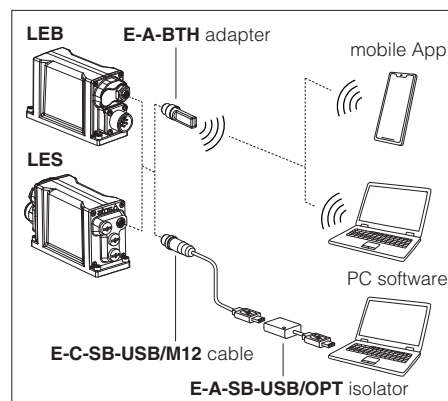

4 BLUETOOTH OPTION - see tech. table **GS500**

T option adds Bluetooth® connectivity to Atos valve drivers thanks to E-A-BTH adapter, which can be left permanently installed on-board, to allow the Bluetooth connection with the valve drivers at any time. E-A-BTH adapter can also be purchased separately and used to connect with any supported Atos digital product.

Bluetooth connection to the valve can be protected against unauthorised access by setting a personal password. The adapter leds visually indicates the status of valve driver and Bluetooth connection.



WARNING: for the list of countries where the Bluetooth adapter has been approved, see tech. table **GS500**
T option is not available for the Indian market, so the Bluetooth adapter must be ordered separately.

5 SMART TUNING

Smart tuning allows to adjust the valve dynamic response in order to match different performance requirements.

The valve is provided with 3 factory settings for the spool control:

- **dynamic** fast response time and high sensitivity for best dynamic performances. Default factory setting for directional valves
- **balanced** average response time and sensitivity suitable for major applications
- **smooth** attenuated response time and sensitivity to improve control stability in critical applications or in environments with electrical disturbances

Smart tuning setting can be switched from Dynamic (default) to Balanced or Smooth via software or fieldbus; if requested, performances can be further customized directly tuning each single control parameter. For details consult related manuals E-MAN-RI-* and Quickstart, see section [28](#).

For Response time and Bode diagrams see section [15](#).

6 IO-LINK - only for **LEB**, see tech. table **GS520**

IO-Link allows low cost digital communication between the valve and machine central unit. The valve is directly connected to a port of an IO-Link master (point-to-point connection) via low-cost unshielded cables for digital reference, diagnostic and settings. The IO-Link master works as a hub exchanging this information with the machine central unit via fieldbus.

7 FIELDBUS - only for **LES**, see tech. table **GS510**

Fieldbus allows valve direct communication with machine control unit for digital reference, valve diagnostics and settings. These execution allow to operate the valves through fieldbus or analog signals available on the main connector.

8 ALTERNATED p/Q CONTROLS - only for **LES**, see tech. table **FS500**

S* options add the closed loop control of pressure (**SP**) or force (**SF** and **SL**) to the basic functions of proportional directional valves flow regulation. A dedicated algorithm alternates pressure (force) depending on the actual hydraulic system conditions.

An additional connector is available for transducers to be interfaced to the valve's driver (1 pressure transducer for SP, 2 pressure transducers for SF or 1 load cell for SL). The alternated pressure control (SP) is possible only for specific installation conditions.

Main 12 pin connector is the same as /Z option plus two analog signals specific for the pressure (force) control.

9 AXIS CONTROLLER - see tech. table **FS630**

Digital servoproportional with on-board electronics **LEZ** include valve's driver plus axis controller, performing position closed loop of any hydraulic actuator equipped with analog, encoder or SSI position transducer. **S*** option add alternated p/Q control to the basic position ones.

Atos also supplies complete servoactuators integrating servocylinder, digital servoproportional valve and axis controller, fully assembled and tested. For more information consult Atos Technical Office.

10 SAFETY OPTIONS - only for **LES**

Atos range of proportional directional valves, provides functional safety options **/U** and **/K**, designed to accomplish a safety function, intended to reduce the risk in process control systems.

They are TÜV certified in compliance to IEC 61508 up to SIL 3 and ISO 13849 up to category 4, PL e



Safe double power supply, option **/U**: the driver has separate power supplies for logic and solenoids. The safe condition is reached by cutting the electrical supply to solenoids, while electronics remains active for monitoring functions and fieldbus communication, see tech table **FY100**

Safety function via on/off signals, option **/K**: upon a disable command, the driver checks the spool position and it provides an on/off acknowledgement signal only when the valve is in safe condition, see tech table **FY200**

11 GENERAL CHARACTERISTICS

Assembly position	Any position
Subplate surface finishing to ISO 4401	Acceptable roughness index: Ra ≤0,8, recommended Ra 0,4 – Flatness ratio 0,01/100
MTTFd valves according to EN ISO 13849	75 years, for further details see technical table P007
Ambient temperature range	Standard = -20°C ÷ +60°C /PE option = -20°C ÷ +60°C /BT option = -40°C ÷ +60°C
Storage temperature range	Standard = -20°C ÷ +70°C /PE option = -20°C ÷ +70°C /BT option = -40°C ÷ +70°C
Surface protection	Zinc coating with black passivation, galvanic treatment (driver housing)
Corrosion resistance	Salt spray test (EN ISO 9227) > 200 h
Vibration resistance	See technical table G004
Compliance	CE according to EMC directive 2014/30/EU (Immunity: EN 61000-6-2; Emission: EN 61000-6-3) RoHS Directive 2011/65/EU as last update by 2015/863/EU REACH Regulation (EC) n°1907/2006

12 HYDRAULIC CHARACTERISTICS - based on mineral oil ISO VG 46 at 50 °C

Valve model	DPZO-*-1	DPZO-*-2			DPZO-*-4	DPZO-*-4M	DPZO-*-6	DPZO-*-8
Pressure limits [bar]	ports P, A, B, X = 350; T = 250 (10 for option /D); Y = 10;							
Spool type and size	L5, DL5	L3	L5, DL5	T5	L5, DL5		L5	
Nominal flow Δp P-T [l/min] (1)								
Δp= 10 bar	100	160	250	190	480	550	640	1200
Δp= 30 bar	160	270	430	330	830	950	1100	2000
Max permissible flow [l/min]	180	400	550	550	1000	1100	1600	3500
Piloting pressure [bar]	min. = 25; max = 350 (option /G advisable for pilot pressure > 150 bar)							
Piloting volume [cm³/min]	1,4	3,7		9	11,3	21,6	39,8	
Piloting flow (2) [l/min]	3,5	9		18	20	19	24	
Leakage (3) Pilot [cm³/min]	100 / 300	150 / 450		200 / 600	200 / 600	900 / 2800	900 / 2800	
Main stage [l/min]	0,4 / 1,2	0,6 / 2,5		1,0 / 4,0	1,0 / 4,0	3,0 / 9,0	6,0 / 20	
Response time (4) [ms]	≤ 25	≤ 25		≤ 30	≤ 35	≤ 80	≤ 100	
Hysteresis	≤ 0,1 [%of max regulation]							
Repeatability	± 0,1 [%of max regulation]							
Thermal drift	zero point displacement < 1% at ΔT = 40°C							

(1) For different Δp, the max flow is in accordance to the diagrams in section 15.2

(3) At p = 100/350 bar

(2) With step reference input signal 0 ÷ 100 %

(4) 0-100% step signal, see detailed diagrams in section 15.3

13 ELECTRICAL CHARACTERISTICS

Power supplies	Nominal : +24 VDC Rectified and filtered : VRMS = 20 ÷ 32 VMAX (ripple max 10 % VPP)				
Max power consumption	50 W				
Max. solenoid current	2,6 A				
Coil resistance R at 20°C	3 ÷ 3,3 Ω				
Analog input signals	Voltage: range ±10 VDC (24 VMAX tolerant)		Input impedance: Ri > 50 kΩ		
	Current: range ±20 mA		Input impedance: Ri = 500 Ω		
Monitor outputs	Output range: voltage ±10 VDC @ max 5 mA current ±20 mA @ max 500 Ω load resistance				
Enable input	Range: 0 ÷ 5 VDC (OFF state), 9 ÷ 24 VDC (ON state), 5 ÷ 9 VDC (not accepted); Input impedance: Ri > 10 kΩ				
Fault output	Output range: 0 ÷ 24 VDC (ON state > [power supply - 2 V] ; OFF state < 1 V) @ max 50 mA; external negative voltage not allowed (e.g. due to inductive loads)				
Pressure/Force transducer power supply (only for SP, SF, SL)	+24VDC @ max 100 mA (E-ATR-8 see tech table GS465)				
Alarms	Solenoid not connected/short circuit, cable break with current reference signal, over/under temperature, valve spool transducer malfunctions, alarms history storage function				
Insulation class	H (180°) Due to the occurring surface temperatures of the solenoid coils, the European standards ISO 13732-1 and EN982 must be taken into account				
Protection degree to DIN EN60529	IP66 / IP67 with mating connectors				
Duty factor	Continuous rating (ED=100%)				
Tropicalization	Tropical coating on electronics PCB				
Additional characteristics	Short circuit protection of solenoid's current supply; 3 leds for diagnostic (only for LES); spool position control (SN) or pressure/force control (SP, SF, SL) by P.I.D. with rapid solenoid switching; protection against reverse polarity of power supply				
Communication interface	USB	IO-Link	CANopen	PROFIBUS DP	EtherCAT POWERLINK EtherNet/IP PROFINET IO RT/IRT
	Atos ASCII coding	Interface and System Specification 1.1.3	EN50325-4 + DS408	EN50170-2/IEC61158	IEC 61158
Communication physical layer	not insulated USB 2.0+USB OTG	SDCI class port B	optical insulated CAN ISO11898	optical insulated RS485	Fast Ethernet, insulated 100 Base TX
Recommended wiring cable	LiYCY shielded cables, see section 24				

Note: a maximum time of 800 ms (depending on communication type) has to be considered between the driver energizing with the 24 VDC power supply and when the valve is ready to operate. During this time the current to the valve coils is switched to zero.

14 SEALS AND HYDRAULIC FLUIDS - for other fluids not included in below table, consult our technical office

Seals, recommended fluid temperature	NBR seals (standard) = -20°C ÷ +60°C, with HFC hydraulic fluids = -20°C ÷ +50°C FKM seals (/PE option) = -20°C ÷ +80°C NBR low temp. seals (/BT option) = -40°C ÷ +60°C, with HFC hydraulic fluids = -20°C ÷ +50°C		
Recommended viscosity	20 ÷ 100 mm ² /s - max allowed range 15 ÷ 380 mm ² /s		
Max fluid contamination level	normal operation	ISO4406 class 18/16/13	NAS1638 class 7
	longer life	ISO4406 class 16/14/11	NAS1638 class 5
		see also filter section at www.atos.com or KTF catalog	
Hydraulic fluid	Suitable seals type	Classification	Ref. Standard
Mineral oils	NBR, FKM, NBR low temp.	HL, HLP, HLPD, HVLP, HVLPD	DIN 51524
Flame resistant without water	FKM	HFDU, HFDR	ISO 12922
Flame resistant with water	NBR, NBR low temp.	HFC	

15 DIAGRAMS (based on mineral oil ISO VG 46 at 50 °C)

15.1 Regulation diagrams (values measure at Δp 10 bar P-T)

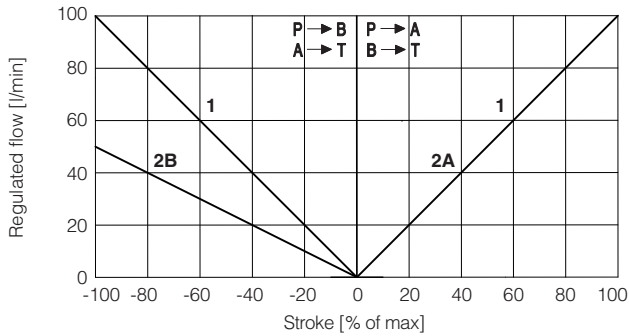

DPZO-1: 1 = L5 2A = DL5 (P → A, A → T)
2B = DL5 (P → B, B → T)

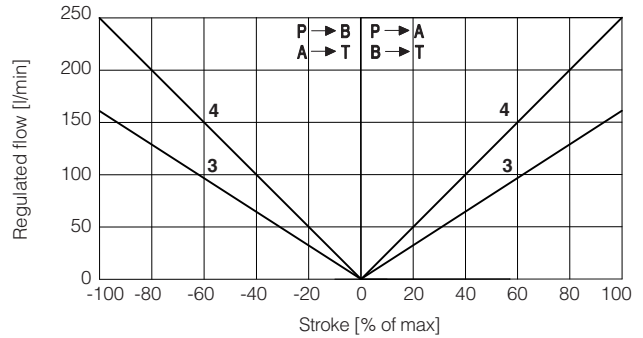

DPZO-2: 3 = L3 4 = L5

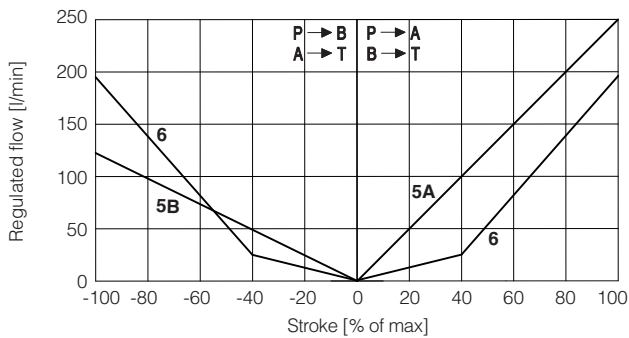

DPZO-2: 5A = DL5 (P → A, A → T)
5B = DL5 (P → B, B → T) 6 = T5

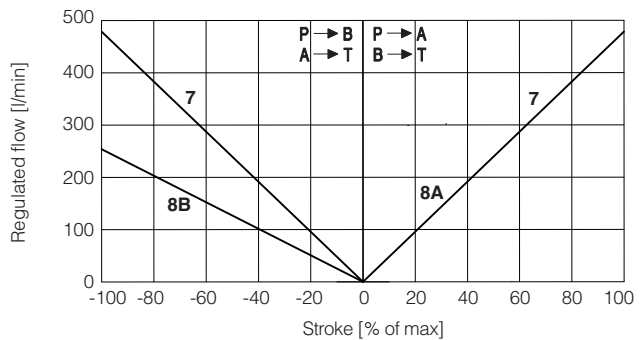

DPZO-4: 7 = L5 8A = DL5 (P → A, A → T)
8B = DL5 (P → B, B → T)

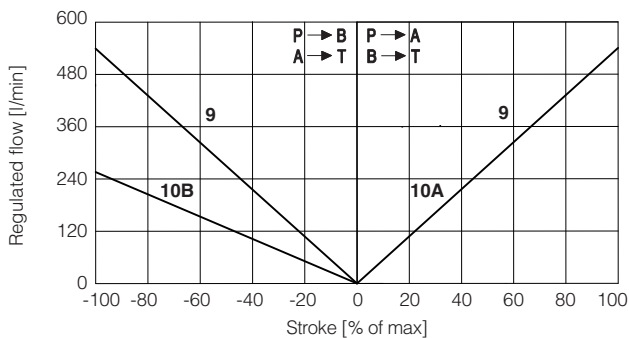

DPZO-4M: 9 = L5 10A = DL5 (P → A, A → T)
10B = DL5 (P → B, B → T)

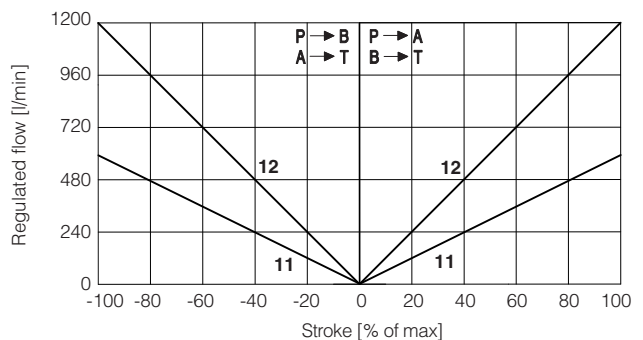

DPZO-6: 11 = L5
DPZO-8: 12 = L5

15.2 Flow / Δp diagram - stated at 100% of spool stroke

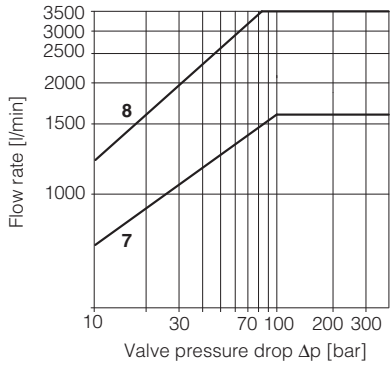
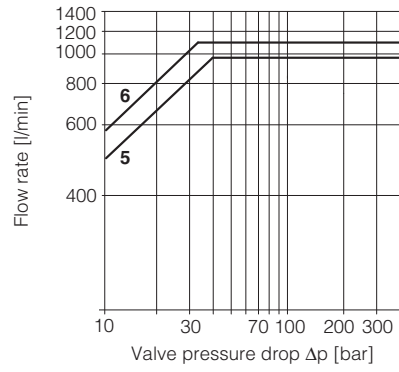
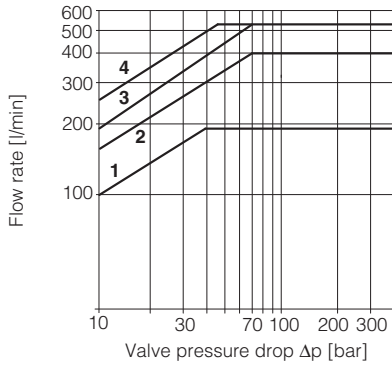

- | | | |
|--------------------------------------|---------------------------------------|--------------------------|
| DPZO-1:
1 = spools L5, DL5 | DPZO-4:
5 = spools L5, DL5 | DPZO-6:
7 = L5 |
| DPZO-2:
2 = spools L3 | DPZO-4M:
6 = spools L5, DL5 | DPZO-8:
8 = L5 |
| DPZO-3:
3 = spool T5 | | |
| DPZO-4:
4 = spools L5, DL5 | | |

Note: Hydraulic configuration vs. reference signal for configurations 60 and 70 (standard and option /B)

Reference signal $\left. \begin{matrix} 0 \div +10 \text{ V} \\ 12 \div 20 \text{ mA} \end{matrix} \right\} P \rightarrow A / B \rightarrow T$

Reference signal $\left. \begin{matrix} 0 \div -10 \text{ V} \\ 4 \div 12 \text{ mA} \end{matrix} \right\} P \rightarrow B / A \rightarrow T$

15.3 Response time

The response times in below diagrams are measured at different steps of the reference input signal. They have to be considered as average values.

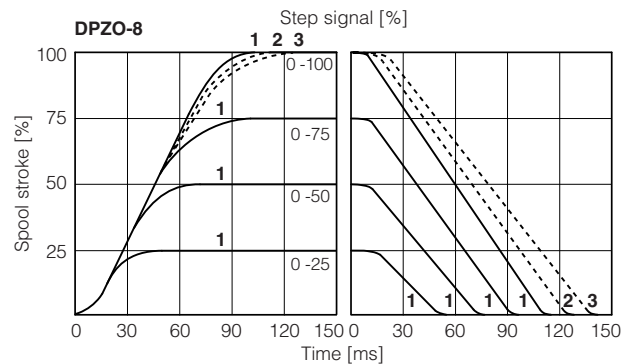
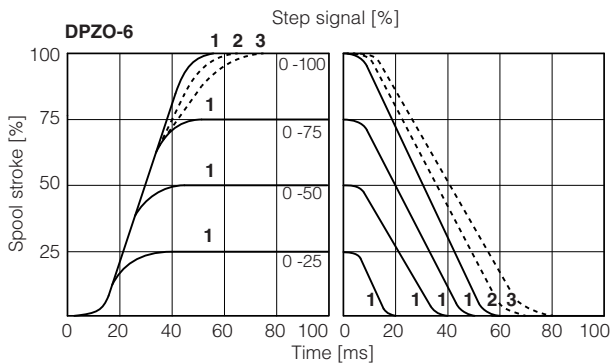
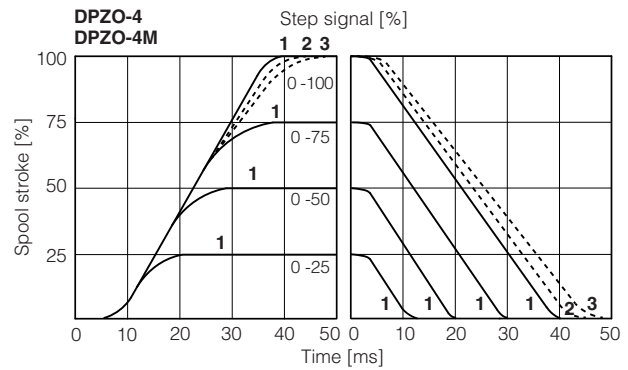
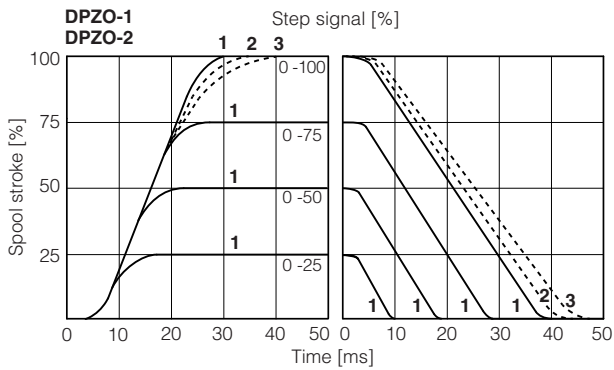

1 = dynamic 2 = balanced (*) 3 = smooth (*)

(*) Response time is represented only for 0-100% step; for intermediate steps, the response time increment of presets 2 (balanced) and 3 (smooth) with respect to the preset 1 (dynamic) is proportional to the step amplitude of the reference input signal

15.4 Bode diagrams DPZO-1, DPZO-2

Stated at nominal hydraulic conditions

± 5% nominal stroke:

- 1 = dynamic
- 2 = balanced
- 3 = smooth

± 100% nominal stroke:

- 4 = dynamic
- 5 = balanced
- 6 = smooth

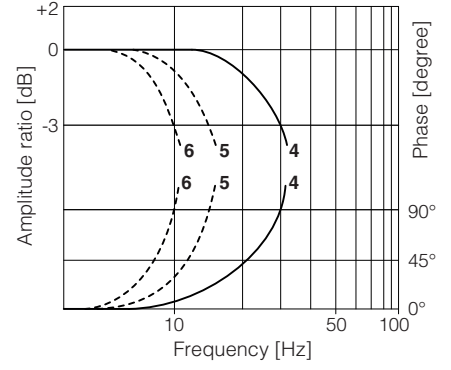
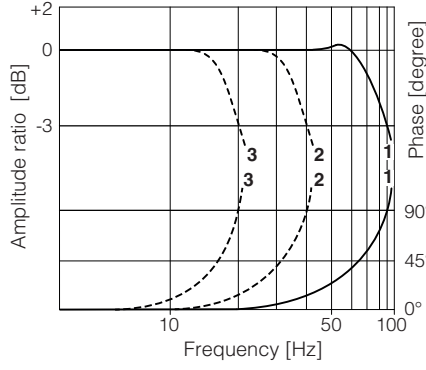

15.5 Bode diagrams DPZO-4, DPZO-4M

Stated at nominal hydraulic conditions

± 5% nominal stroke:

- 1 = dynamic
- 2 = balanced
- 3 = smooth

± 100% nominal stroke:

- 4 = dynamic
- 5 = balanced
- 6 = smooth

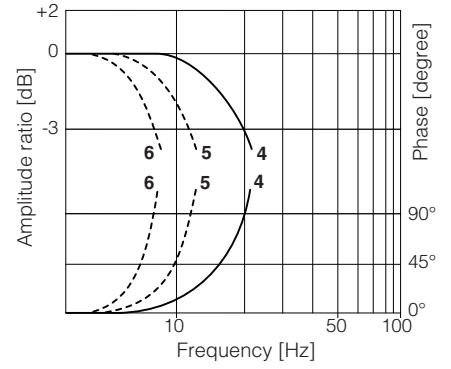
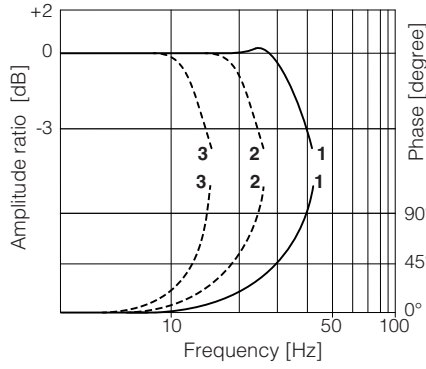

15.6 Bode diagrams DPZO-6

Stated at nominal hydraulic conditions

± 5% nominal stroke:

- 1 = dynamic
- 2 = balanced
- 3 = smooth

± 100% nominal stroke:

- 4 = dynamic
- 5 = balanced
- 6 = smooth

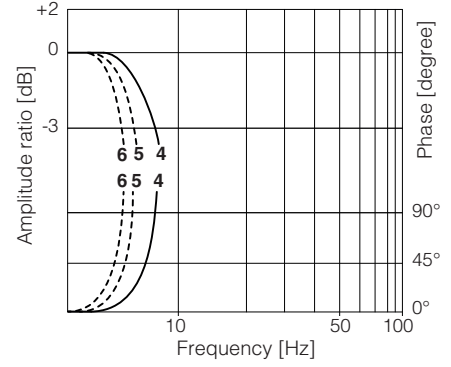
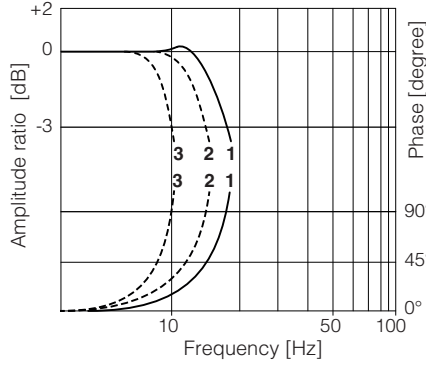

15.7 Bode diagrams DPZO-8

Stated at nominal hydraulic conditions

± 5% nominal stroke:

- 1 = dynamic
- 2 = balanced
- 3 = smooth

± 100% nominal stroke:

- 4 = dynamic
- 5 = balanced
- 6 = smooth

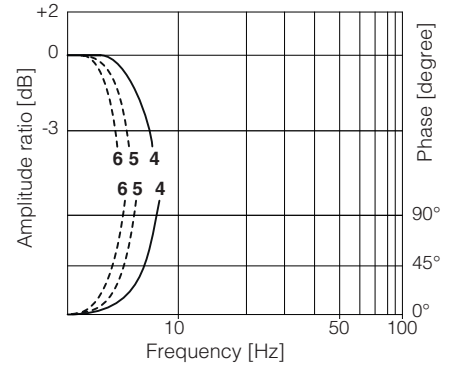
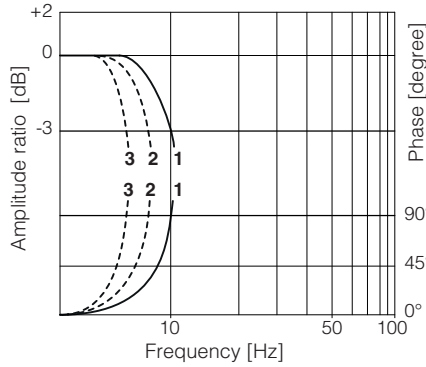

15.8 Pressure gain

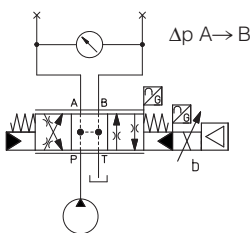

- 9 = DPZO-1
- 10 = DPZO-2
- DPZO-4
- DPZO-4M
- DPZO-6
- DPZO-8

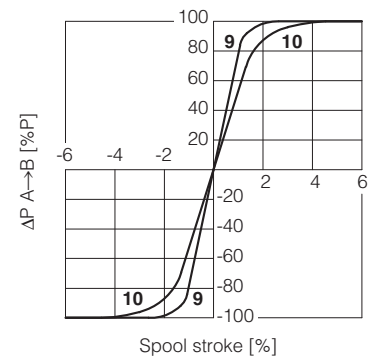

16 HYDRAULIC OPTIONS

- B** = Solenoid, on-board digital driver and LVDT transducer at side of port B of the main stage (side A of pilot valve). For hydraulic configuration vs reference signal, see 15.1
- D** = Internal drain (through port T).
Pilot and drain configuration can be modified as shown in the functional scheme here aside. For detailed view of plugs position, see section 25
The valve's standard configuration provides internal pilot and external drain.
- E** = External pilot (through port X).
Pilot and drain configuration can be modified as shown in the functional scheme here aside. For detailed view of plugs position, see section 25
The valve's standard configuration provides internal pilot and external drain.
- G** = Pressure reducing valve ③ with fixed setting, installed between pilot valve and main body. Reduced pressure setting:
DPZO-1, DPZO-2, DPZO-4(M), DPZO-6 and DPZO-8 = **40 bar**
It is advisable for valves with internal pilot in case of system pressure higher than 150 bar.
Pressure reducing valve ③ is standard for DPZO-1, for other sizes add /G option.

Functional Scheme - example of configuration 70

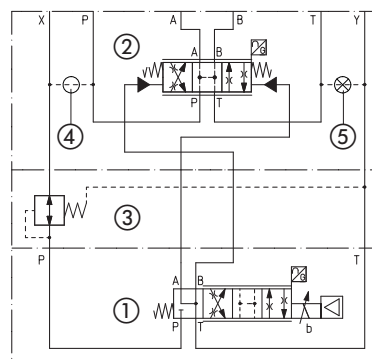

- ① Pilot valve
② Main stage
③ Pressure reducing valve
④ Plug to be added for external pilot trough port X
⑤ Plug to be removed for internal drain through port T

17 ELECTRONIC OPTIONS - not available for LEB-SN-IL

- F** = This option permits to monitor the eventual fault condition of the driver, as for example the solenoid short circuit/not connected, reference signal cable broken for option /I, spool position transducer broken, etc. - see 20.9 for signal specifications.
- I** = This option provides 4 ÷ 20 mA current reference and monitor signals, instead of the standard ±10 VDC.
Input signal can be reconfigured via software selecting between voltage and current, within a maximum range of ±10 VDC or ±20 mA.
It is normally used in case of long distance between the machine control unit and the valve or where the reference signal can be affected by electrical noise; the valve functioning is disabled in case of reference signal cable breakage.
- Q** = This option permits to inhibit the valve function without removing the power supply to the driver. Upon disable command the current to the solenoid is zeroed and the valve's spool moves to rest position.
The option /Q is suggested for all cases where the valve has to be frequently inhibited during the machine cycle – see 20.7 for signal specifications.
- Z** = This option provides, on the 12 pin main connector, the following additional features:
Fault output signal - see above option /F
Enable input signal - see above option /Q
Repeat enable output signal - only for LEB-SN-NP (see 20.8)
Power supply for driver's logics and communication - only for LES (see 20.2)
- C** = This option is available to connect pressure (force) transducers with 4 ÷ 20 mA current output signal, instead of the standard ±10 VDC.
Input signal can be reconfigured via software selecting between voltage and current, within a maximum range of ±10 VDC or ±20 mA.

18 POSSIBLE COMBINED OPTIONS

Hydraulic options:

all combination possible

Electronics options - Standard versions:

LEB-SN, LES-SN

/F/I, /I/Q, /I/Z

LES-SP, SF, SL

/C/I

Electronics options - Safety certified versions:

LES-SN

/I/U, /I/K

LES-SP, SF, SL

/C/U, /I/U, /C/I/U, /C/K, /I/K, /C/I/K

Note: /T Bluetooth adapter option can be combined with all other options

19 SAFETY REST POSITION - configuration 70

In absence of electric power supply (+24 VDC), the valve main spool is moved by the springs force to the **safety rest position** characterized by a small offset of about 1% to 6% of the total stroke in P-B / A-T configuration.

This is specifically designed to avoid that in case of accidental interruption of the electrical power supply to the valve, the actuator moves towards an undefined direction (due to the tolerances of the zero overlap spool), with potential risk of damages or personnel injury.

Thanks to the **safety rest position** the actuator movement is suddenly stopped and it is recovered at very low speed towards the direction corresponding to the P-B/ A-T connection.

The main spool moves to the closed loop control position (zero overlap) when the pilot pressure is activated, the valve is fed with power supply +24 VDC and reference input = 0V (or 12 mA for option /I) is applied to the driver.

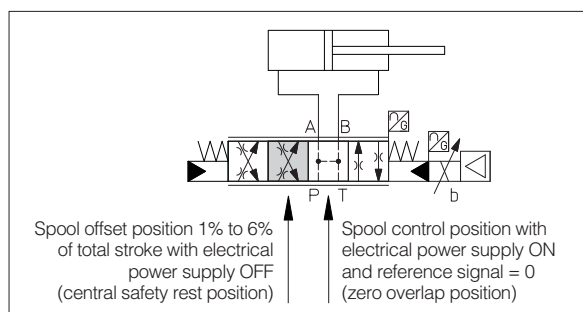

20 POWER SUPPLY AND SIGNALS SPECIFICATIONS

Generic electrical output signals of the valve (e.g. fault or monitor signals) must not be directly used to activate safety functions, like to switch-ON/OFF the machine's safety components, as prescribed by the European standards (Safety requirements of fluid technology systems and components-hydraulics, ISO 4413).

For **LEB-SN-IL** signals see section 21

For certified safety options: **/U** see tech. table **FY100** and **/K** see tech. table **FY200**

20.1 Power supply (V+ and V0)

The power supply must be appropriately stabilized or rectified and filtered: apply at least a 10000 μ F/40 V capacitance to single phase rectifiers or a 4700 μ F/40 V capacitance to three phase rectifiers. In case of separate power supply see 20.2.



A safety fuse is required in series to each power supply: 2,5 A time lag fuse.

20.2 Power supply for driver's logic and communication (VL+ and VL0) - only for LES with /Z option and for LES-SP, SF, SL with fieldbus

The power supply for driver's logic and communication must be appropriately stabilized or rectified and filtered: apply at least a 10000 μ F/40 V capacitance to single phase rectifiers or a 4700 μ F/40 V capacitance to three phase rectifiers.

The separate power supply for driver's logic on pin 9 and 10, allow to remove solenoid power supply from pin 1 and 2 maintaining active the diagnostics, USB and fieldbus communications.



A safety fuse is required in series to each driver's logic and communication power supply: 500 mA fast fuse.

20.3 Flow reference input signal (Q_INPUT+)

The driver controls in closed loop the valve spool position proportionally to the external reference input signal.

Reference input signal is factory preset according to selected valve code, defaults are ± 10 VDC for standard and $4 \div 20$ mA for /I option.

Input signal can be reconfigured via software selecting between voltage and current, within a maximum range of ± 10 VDC or ± 20 mA.

Drivers with fieldbus interface can be software set to receive reference signal directly from the machine control unit (fieldbus reference).

Analog reference input signal can be used as on-off commands with input range $0 \div 24$ VDC.

20.4 Pressure or force reference input signal (F_INPUT+) - only for LES-SP, SF, SL

Functionality of F_INPUT+ signal (pin 7), is used as reference for the driver pressure/force closed loop (see tech. table **FS500**).

Reference input signal is factory preset according to selected valve code, defaults are ± 10 VDC for standard and $4 \div 20$ mA for /I option.

Input signal can be reconfigured via software selecting between voltage and current, within a maximum range of ± 10 VDC or ± 20 mA.

Drivers with fieldbus interface can be software set to receive reference signal directly by the machine control unit (fieldbus reference).

Analog reference input signal can be used as on-off commands with input range $0 \div 24$ VDC.

20.5 Flow monitor output signal (Q_MONITOR) - not for /F

The driver generates an analog output signal proportional to the actual spool position of the valve; the monitor output signal can be software set to show other signals available in the driver (e.g. analog reference, fieldbus reference, pilot spool position).

Monitor output signal is factory preset according to selected valve code, defaults are ± 10 VDC for standard and $4 \div 20$ mA for /I option.

Output signal can be reconfigured via software selecting between voltage and current, within a maximum range of ± 10 VDC or ± 20 mA.

20.6 Pressure or force monitor output signal (F_MONITOR) - only for LES-SP, SF, SL

The driver generates an analog output signal proportional to alternated pressure/force control; the monitor output signal can be software set to show other signals available in the driver (e.g. analog reference, force reference).

Monitor output signal is factory preset according to selected valve code, defaults are ± 10 VDC for standard and $4 \div 20$ mA for /I option.

Output signal can be reconfigured via software selecting between voltage and current, within a maximum range of ± 10 VDC or ± 20 mA.

20.7 Enable input signal (ENABLE) - not for standard and /F

To enable the driver, supply a 24 VDC on pin 3 (pin C): Enable input signal allows to enable/disable the current supply to the solenoid, without removing the electrical power supply to the driver; it is used to active the communication and the other driver functions when the valve must be disabled for safety reasons. This condition **does not comply** with norms IEC 61508 and ISO 13849.

Enable input signal can be used as generic digital input by software selection.

20.8 Repeat enable output signal (R_ENABLE) - only for LEB-SN-NP with /Z option

Repeat enable is used as output repeater signal of enable input signal (see 20.7).

20.9 Fault output signal (FAULT) - not for standard and /Q

Fault output signal indicates fault conditions of the driver (solenoid short circuits/not connected, reference signal cable broken for $4 \div 20$ mA input, spool position transducer cable broken, etc.). Fault presence corresponds to 0 VDC, normal working corresponds to 24 VDC.

Fault status is not affected by the Enable input signal. Fault output signal can be used as digital output by software selection.

20.10 Remote pressure/force transducer input signal - only for LES-SP, SF, SL

Analog remote pressure transducers or load cell can be directly connected to the driver (see 22.5).

Analog input signal is factory preset according to selected valve code, defaults are ± 10 VDC for standard and $4 \div 20$ mA for /C option.

Input signal can be reconfigured via software selecting between voltage and current, within a maximum range of ± 10 VDC or ± 20 mA.

Refer to pressure/force transducer characteristics to select the transducer type according to specific application requirements (see tech table **FS500**).

20.11 Multiple PID selection (D_IN0 and D_IN1) - only NP execution for LES-SP, SF, SL

Two on-off input signals are available on the main connector to select one of the four pressure (force) PID parameters setting, stored into the driver.

Switching the active setting of pressure PID during the machine cycle allows to optimize the system dynamic response in different hydraulic working conditions (volume, flow, etc.).

Supply a 24 VDC or a 0 VDC on pin 9 and/or pin 10, to select one of the PID settings as indicated by binary code table at side. Gray code can be selected by software.

PID SET SELECTION				
PIN	SET 1	SET 2	SET 3	SET 4
9	0	24 Vdc	0	24 Vdc
10	0	0	24 Vdc	24 Vdc

21 IO-LINK SIGNALS SPECIFICATIONS - only for LEB-SN-IL

21.1 Power supply for IO-Link communication (L+ and L-)

The IO-Link master provides dedicated 24 Vdc power supply for IO-Link communication.

Maximum power consumption: 2 W

Internal electrical isolation of power L+, L- from P24, N24

21.2 Power supply for driver's logic and valve regulation (P24 and N24)

The IO-Link master provides dedicated 24 Vdc power supply for valve regulation, logics and diagnostics.

Maximum power consumption: 50 W

Internal electrical isolation of power P24, N24 from L+, L-

21.3 IO-Link data line (C/Q)

C/Q signal is used to establish communication between IO-Link master and valve.

22 ELECTRONIC CONNECTIONS

For electronic connection of certified safety options /U see tech. table **FY100** and /K see tech. table **FY200**

22.1 Main connector signals - 7 pin (A1) Standard, /Q and /F options

PIN	Standard	/Q	/F	TECHNICAL SPECIFICATIONS	NOTES
A	V+			Power supply 24 Vdc	Input - power supply
B	V0			Power supply 0 Vdc	Gnd - power supply
C	AGND		AGND	Analog ground	Gnd - analog signal
		ENABLE		Enable (24 Vdc) or disable (0 Vdc) the valve, referred to V0	Input - on/off signal
D	Q_INPUT+			Flow reference input signal: ± 10 Vdc / ± 20 mA maximum range Defaults are ± 10 Vdc for standard and $4 \div 20$ mA for /I option	Input - analog signal Software selectable
E	INPUT-			Negative reference input signal for Q_INPUT+	Input - analog signal
F	Q_MONITOR referred to:			Flow monitor output signal: ± 10 Vdc / ± 20 mA maximum range Defaults are ± 10 Vdc for standard and $4 \div 20$ mA for /I option	Output - analog signal Software selectable
	AGND	V0			
G			FAULT	Fault (0 Vdc) or normal working (24 Vdc)	Output - on/off signal
	EARTH				

22.2 Main connector signals - 12 pin (A2) /Z option and LES-SP, SF, SL

PIN	LEB-SN /Z	LES-SN /Z	LES-SP, SF, SL Fieldbus NP		TECHNICAL SPECIFICATIONS	NOTES
1	V+				Power supply 24 Vdc	Input - power supply
2	V0				Power supply 0 Vdc	Gnd - power supply
3	ENABLE referred to: V0 VL0 VL0 V0				Enable (24 Vdc) or disable (0 Vdc) the valve	Input - on/off signal
4	Q_INPUT+				Flow reference input signal: ± 10 Vdc / ± 20 mA maximum range Defaults are ± 10 Vdc for standard and $4 \div 20$ mA for /I option	Input - analog signal Software selectable
5	INPUT-				Negative reference input signal for Q_INPUT+ and F_INPUT+	Input - analog signal
6	Q_MONITOR referred to:				Flow monitor output signal: ± 10 Vdc / ± 20 mA maximum range Defaults are ± 10 Vdc for standard and $4 \div 20$ mA for /I option	Output - analog signal Software selectable
	AGND	VL0	VL0	V0		
7	AGND				Analog ground	Gnd - analog signal
		NC			Do not connect	
8			F_INPUT+		Pressure/Force reference input signal: ± 10 Vdc / ± 20 mA maximum range Defaults are ± 10 Vdc for standard and $4 \div 20$ mA for /I option	Input - analog signal Software selectable
	R_ENABLE					
9			NC		Do not connect	
		VL+			Power supply 24 Vdc for driver's logic and communication	Input - power supply
10			D_IN0		Multiple pressure/force PID selection, referred to V0	Input - on/off signal
	NC				Do not connect	
11			VL0		Power supply 0 Vdc for driver's logic and communication	Gnd - power supply
			D_IN1		Multiple pressure/force PID selection (not available for SF), referred to V0	Input - on/off signal
11	FAULT referred to: V0 VL0 VL0 V0				Fault (0 Vdc) or normal working (24 Vdc)	Output - on/off signal
PE	EARTH				Internally connected to the driver housing	

Note: do not disconnect VL0 before VL+ when the driver is connected to PC USB port

22.3 IO-Link connector signals - M12 - 5 pin - Coding A, port class B (A) only for **LEB-SN-IL**

PIN	SIGNAL	TECHNICAL SPECIFICATIONS	NOTES
1	L+	Power supply 24 Vdc for IO-Link communication	Input - power supply
2	P24	Power supply 24 Vdc for valve regulation, logics and diagnostics	Input - power supply
3	L-	Power supply 0 Vdc for IO-Link communication	Gnd - power supply
4	C/Q	IO-Link data line	Input / Output - signal
5	N24	Power supply 0 Vdc for valve regulation, logics and diagnostics	Gnd - power supply

Note: L+, L- and P24, N24 are electrically isolated

22.4 Communications connectors (B) - (C)

(B) **USB connector - M12 - 5 pin** always present

PIN	SIGNAL	TECHNICAL SPECIFICATION (1)
1	+5V_USB	Power supply
2	ID	Identification
3	GND_USB	Signal zero data line
4	D-	Data line -
5	D+	Data line +

(C1) (C2) **BC fieldbus execution, connector - M12 - 5 pin**

PIN	SIGNAL	TECHNICAL SPECIFICATION (1)
1	CAN_SHLD	Shield
2	not used	(C1) - (C2) pass-through connection (2)
3	CAN_GND	Signal zero data line
4	CAN_H	Bus line (high)
5	CAN_L	Bus line (low)

(C1) (C2) **BP fieldbus execution, connector - M12 - 5 pin**

PIN	SIGNAL	TECHNICAL SPECIFICATION (1)
1	+5V	Termination supply signal
2	LINE-A	Bus line (high)
3	DGND	Data line and termination signal zero
4	LINE-B	Bus line (low)
5	SHIELD	

(C1) (C2) **EH, EW, EI, EP fieldbus execution, connector - M12 - 4 pin**

PIN	SIGNAL	TECHNICAL SPECIFICATION (1)
1	TX+	Transmitter
2	RX+	Receiver
3	TX-	Transmitter
4	RX-	Receiver
Housing	SHIELD	

(1) Shield connection on connector's housing is recommended

(2) Pin 2 can be fed with external +5V supply of CAN interface

22.5 Remote pressure/force transducer connector - M12 - 5 pin - only for SP, SF, SL (D)

PIN	SIGNAL	TECHNICAL SPECIFICATION	NOTES	(D1) SP, SL - Single transducer (1)		(D2) SF - Double transducers (1)	
				Voltage	Current	Voltage	Current
1	VF +24V	Power supply +24Vdc	Output - power supply	Connect	Connect	Connect	Connect
2	TR1	1st signal transducer: ±10 Vdc / ±20 mA maximum range	Input - analog signal Software selectable	Connect	Connect	Connect	Connect
3	AGND	Common gnd for transducer power and signals	Common gnd	Connect	/	Connect	/
4	TR2	2nd signal transducer: ±10 Vdc / ±20 mA maximum range	Input - analog signal Software selectable	/	/	Connect	Connect
5	NC	Not connect		/	/	/	/

(1) Single/double transducer configuration is software selectable

Remote pressure transducers connection - example

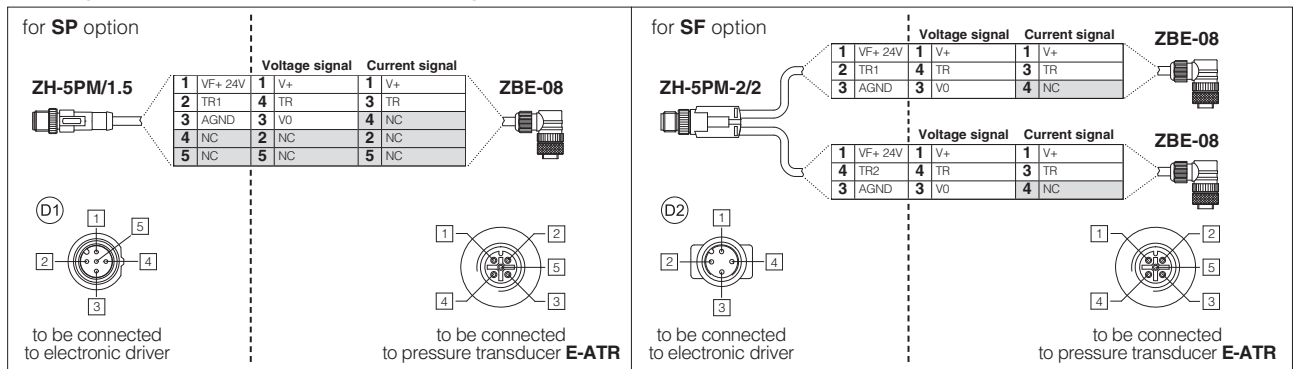

Note: pin layout always referred to driver's view

22.6 LEB-SN-NP connections layout

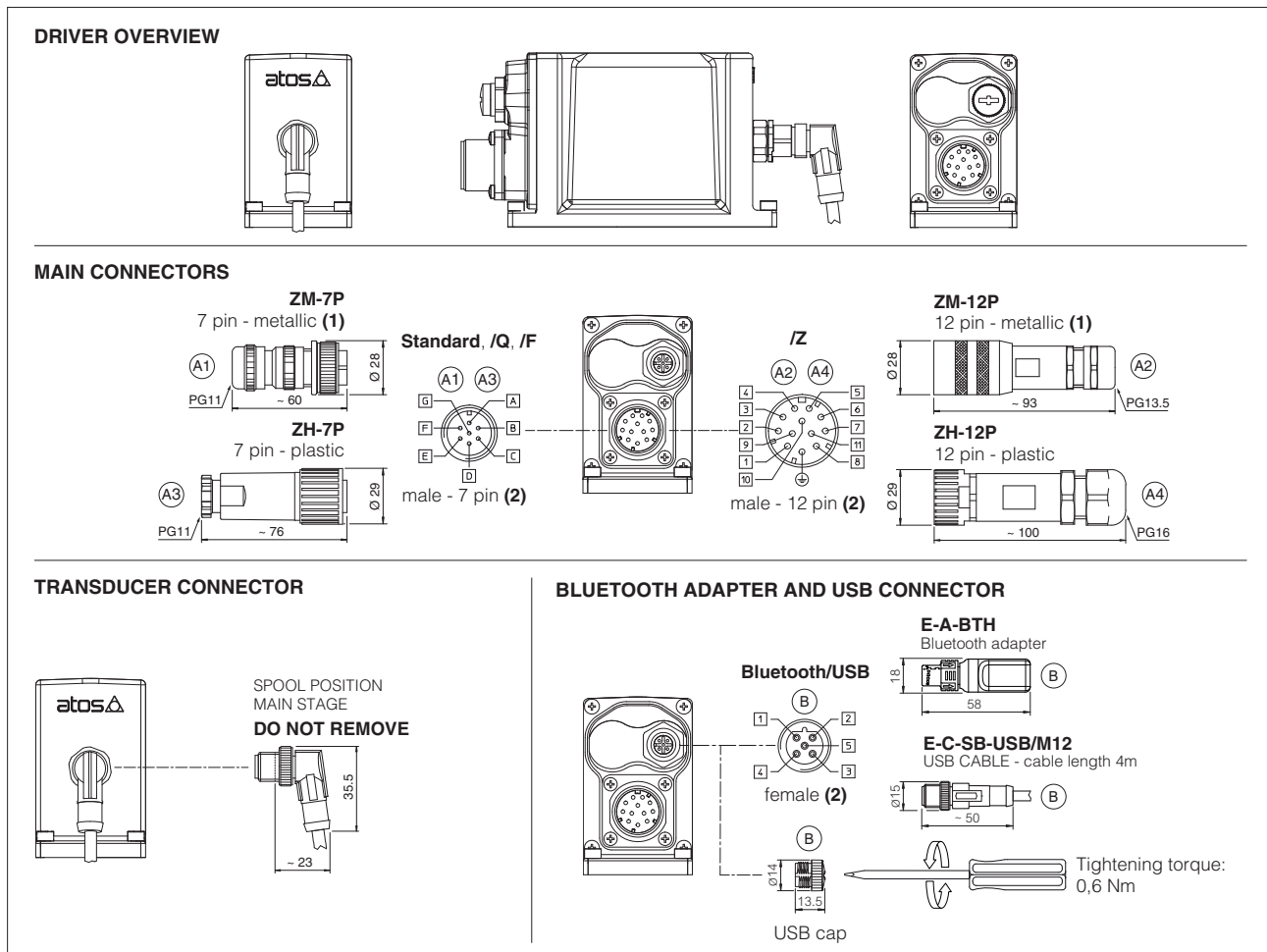

(1) Use of metallic connectors is strongly recommended in order to fulfill EMC requirements (2) Pin layout always referred to driver's view

22.7 LEB-SN-IL connections layout

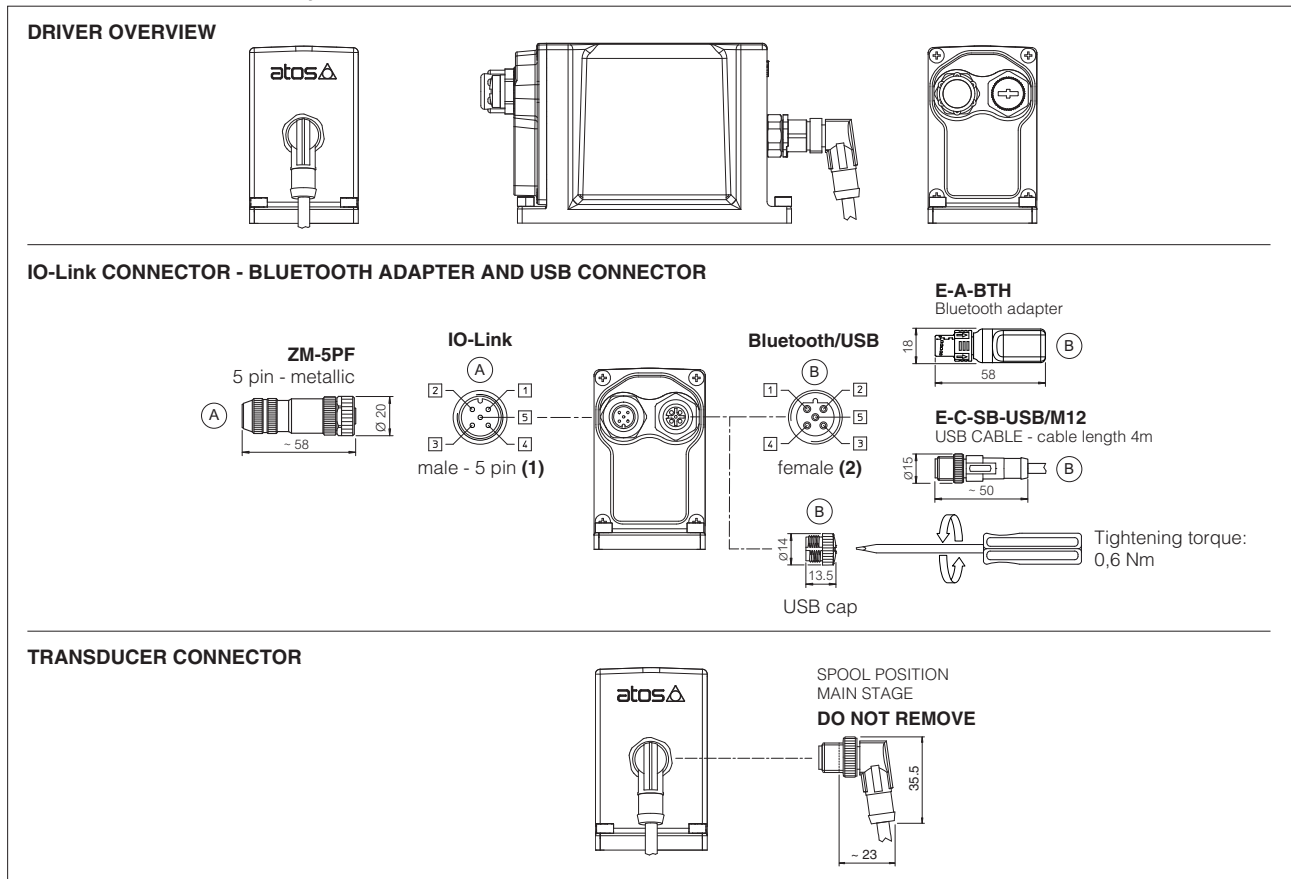

(1) Pin layout always referred to driver's view

22.8 LES connections layout

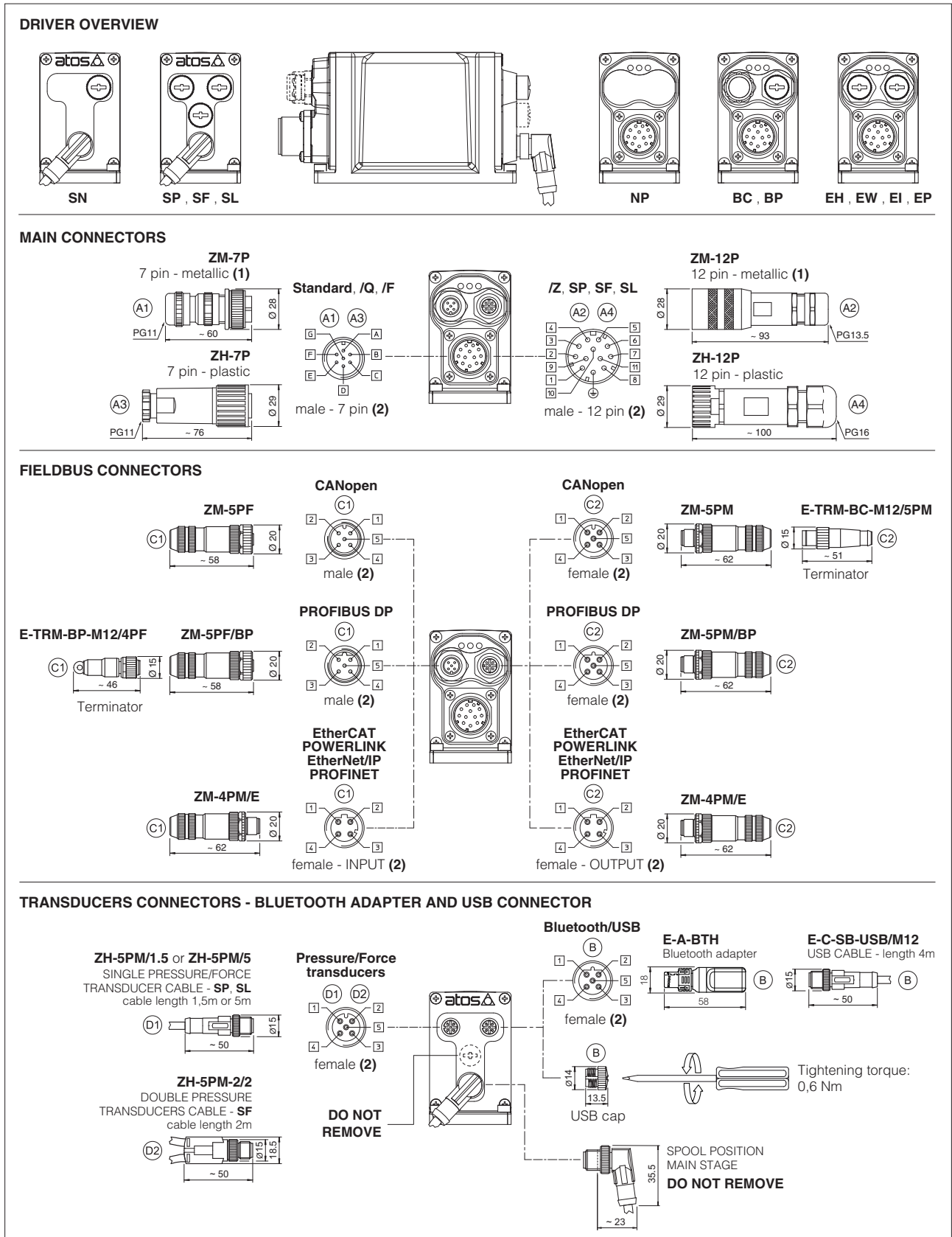

(1) Use of metallic connectors is strongly recommended in order to fulfill EMC requirements (2) Pin layout always referred to driver's view

22.9 Diagnostic LEDs - only for LES

Three leds show driver operative conditions for immediate basic diagnostics. Please refer to the driver user manual for detailed information.

FIELDBUS	NP	BC	BP	EH	EW	EI	EP	
LEDS	Not Present	CANopen	PROFIBUS DP	EtherCAT	POWERLINK	EtherNet/IP	PROFINET	
L1		VALVE STATUS			LINK/ACT			
L2		NETWORK STATUS			NETWORK STATUS			
L3		SOLENOID STATUS			LINK/ACT			

23 IN / OUT FIELDBUS COMMUNICATION CONNECTORS

Two fieldbus communication connectors are always available for digital drivers executions BC, BP, EH, EW, EI, EP. This features allows considerable technical advantages in terms of installation simplicity, wirings reduction and also avoid the usage expensive T-connectors.

For BC and BP executions the fieldbus connectors have an internal pass-through connection and can be used like end point of the fieldbus network, using an external terminator (see tech table **GS500**).

For EH, EW, EI and EP executions the external terminators are not required: each connector is internally terminated.

BC and BP pass-through connection

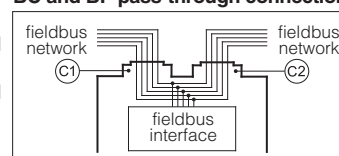

24 CONNECTORS CHARACTERISTICS - to be ordered separately

24.1 Main connectors - 7 pin

CONNECTOR TYPE	POWER SUPPLY AND SIGNALS	POWER SUPPLY AND SIGNALS
CODE	(A1) ZM-7P	(A3) ZH-7P
Type	7pin female straight circular	7pin female straight circular
Standard	According to MIL-C-5015	According to MIL-C-5015
Material	Metallic	Plastic reinforced with fiber glass
Cable gland	PG11	PG11
Recommended cable	LiYCY 7 x 0,75 mm ² max 20 m (logic and power supply) or LiYCY 7 x 1 mm ² max 40 m (logic and power supply)	LiYCY 7 x 0,75 mm ² max 20 m (logic and power supply) or LiYCY 7 x 1 mm ² max 40 m (logic and power supply)
Conductor size	up to 1 mm ² - available for 7 wires	up to 1 mm ² - available for 7 wires
Connection type	to solder	to solder
Protection (EN 60529)	IP 67	IP 67

24.2 Main connectors - 12 pin

CONNECTOR TYPE	POWER SUPPLY AND SIGNALS	POWER SUPPLY AND SIGNALS
CODE	(A2) ZM-12P	(A4) ZH-12P
Type	12pin female straight circular	12pin female straight circular
Standard	DIN 43651	DIN 43651
Material	Metallic	Plastic reinforced with fiber glass
Cable gland	PG13,5	PG16
Recommended cable	LiYCY 12 x 0,75 mm ² max 20 m (logic and power supply)	LiYCY 10 x 0,14mm ² max 40 m (logic) LiYY 3 x 1mm ² max 40 m (power supply)
Conductor size	0,5 mm ² to 1,5 mm ² - available for 12 wires	0,14 mm ² to 0,5 mm ² - available for 9 wires 0,5 mm ² to 1,5 mm ² - available for 3 wires
Connection type	to crimp	to crimp
Protection (EN 60529)	IP 67	IP 67

24.3 IO-Link connector - only for LEB-SN-IL

CONNECTOR TYPE	IL IO-Link
CODE	(A) ZM-5PF
Type	5pin female straight circular
Standard	M12 coding A – IEC 61076-2-101
Material	Metallic
Cable gland	Pressure nut - cable diameter 6÷8 mm
Recommended cable	5 x 0,75 mm ² max 20 m
Connection type	screw terminal
Protection (EN 60529)	IP 67

24.4 Fieldbus communication connectors

CONNECTOR TYPE	BC CANopen (1)		BP PROFIBUS DP (1)		EH EtherCAT, EW POWERLINK, EI EtherNet/IP, EP PROFINET (2)	
CODE	(C1) ZM-5PF	(C2) ZM-5PM	(C1) ZM-5PF/BP	(C2) ZM-5PM/BP	(C1) (C2) ZM-4PM/E	
Type	5 pin female straight circular	5 pin male straight circular	5 pin female straight circular	5 pin male straight circular	4 pin male straight circular	
Standard	M12 coding A – IEC 61076-2-101		M12 coding B – IEC 61076-2-101		M12 coding D – IEC 61076-2-101	
Material	Metallic		Metallic		Metallic	
Cable gland	Pressure nut - cable diameter 6÷8 mm		Pressure nut - cable diameter 6÷8 mm		Pressure nut - cable diameter 4÷8 mm	
Cable	CANbus Standard (DR 303-1)		PROFIBUS DP Standard		Ethernet standard CAT-5	
Connection type	screw terminal		screw terminal		terminal block	
Protection (EN 60529)	IP67		IP 67		IP 67	

(1) E-TRM-** terminators can be ordered separately - see tech table **GS500**

(2) Internally terminated

24.5 Remote pressure/Force transducer connectors - only for SP, SF, SL

CONNECTOR TYPE	SP, SL - Single transducer		SF - Double transducers
CODE	(D1) ZH-5PM/1.5	(D1) ZH-5PM/5	(D2) ZH-5PM-2/2
Type	5 pin male straight circular		4 pin male straight circular
Standard	M12 coding A – IEC 61076-2-101		M12 coding A – IEC 61076-2-101
Material	Plastic		Plastic
Cable gland	Connector moulded on cables 1,5 m length	5 m length	Connector moulded on cables 2 m length
Cable	5 x 0,25 mm ²		3 x 0,25 mm ² (both cables)
Connection type	molded cable		splitting cable
Protection (EN 60529)	IP 67		IP 67

25 PLUGS LOCATION FOR PILOT/DRAIN CHANNELS

Depending on the position of internal plugs, different pilot/drain configurations can be obtained as shown below. To modify the pilot/drain configuration, proper plugs must only be interchanged. The plugs have to be sealed using loctite 270. Standard valves configuration provides internal pilot and external drain.

DPZO-1 Pilot channels

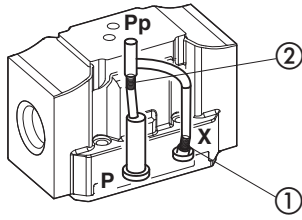

Drain channels

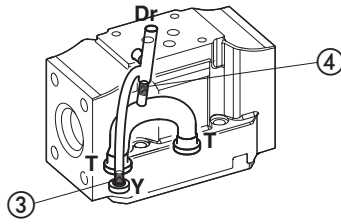

Internal piloting: blinded plug SP-X300F ① in X;
External piloting: blinded plug SP-X300F ② in Pp;
Internal drain: blinded plug SP-X300F ③ in Y;
External drain: blinded plug SP-X300F ④ in Dr.

DPZO-2 Pilot channels

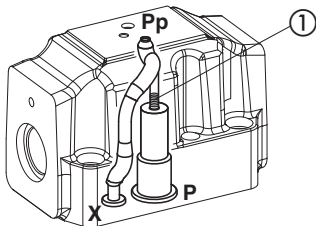

Drain channels

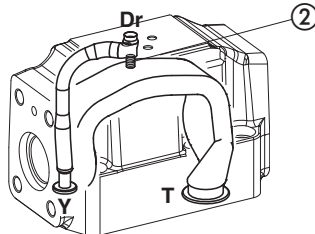

Internal piloting: Without blinded plug SP-X300F ①;
External piloting: Add blinded plug SP-X300F ①;
Internal drain: Without blinded plug SP-X300F ②;
External drain: Add blinded plug SP-X300F ②.

DPZO-4 Pilot channels

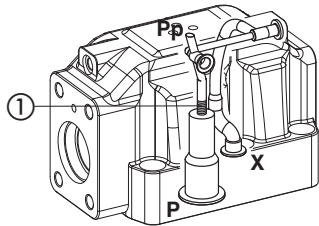

Drain channels

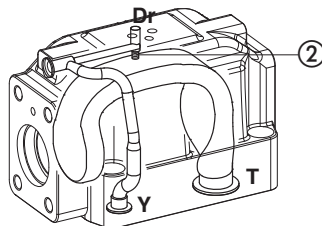

Internal piloting: Without blinded plug SP-X500F ①;
External piloting: Add blinded plug SP-X500F ①;
Internal drain: Without blinded plug SP-X300F ②;
External drain: Add blinded plug SP-X300F ②.

DPZO-6 Pilot channels

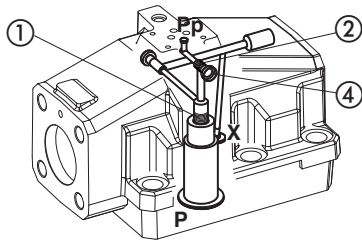

Drain channels

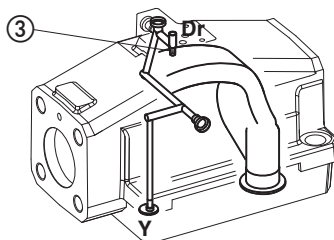

Internal piloting: Without plug ①;
External piloting: Add DIN-908 M16x1,5 in pos ①;
Internal drain: Without blinded plug SP-X300F ③;
External drain: Add blinded plug SP-X300F ③.

DPZO-8 Pilot channels

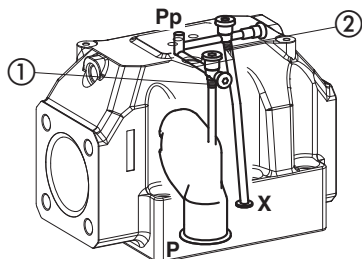

Drain channels

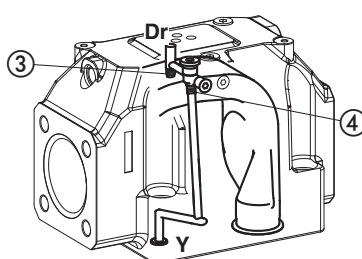

Internal piloting: Without plug ①;
External piloting: Add NPTF 1/8 in pos ①;
 plug NPTF 1/8 in pos ②;
Internal drain: Without plug NPTF 1/8 in pos ③;
 Add plug NPTF 1/8 in pos ④;
External drain: Add plug NPTF 1/8 in pos ③.

DPZO-LEB-*-1
DPZO-LES-*-1

ISO 4401: 2005
Mounting surface: 4401-05-05-0-05 (see table P005)

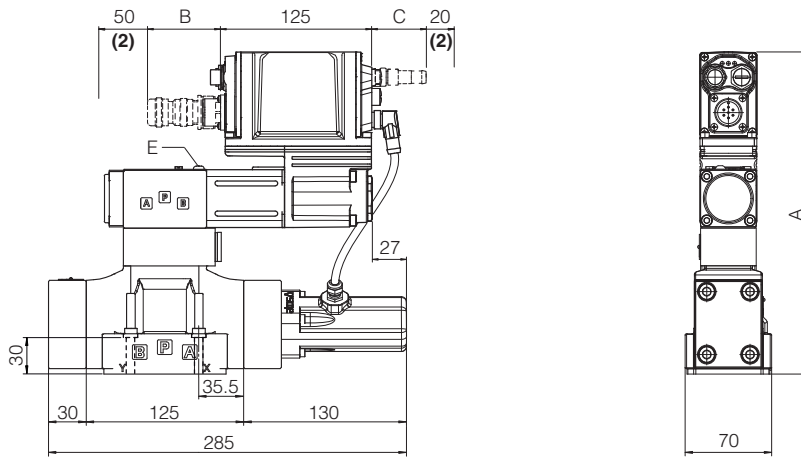

DPZO-*-1	A	B (1)	C (1)	E (air bleeding)	Mass [kg]
LEB - SN - IL	256	60	-		9,8
LEB - SN - NP	256	100	-		
LES - SN - NP, BC, BP, EH	256	100	58		
LES - SN - EW, EI, EP	271	100	58		
LES - SP, SF, SL - *	271	100	58		

- (1) The indicated dimension refers to the longer connectors or Bluetooth adapter
For dimensions of connectors and Bluetooth adapter, see sections 22.6, 22.7 and 22.8
(2) Space required for connection cable and for connector removal

DPZO-LEB-*-2
DPZO-LES-*-2

ISO 4401: 2005
Mounting surface: 4401-07-07-0-05 (see table P005)

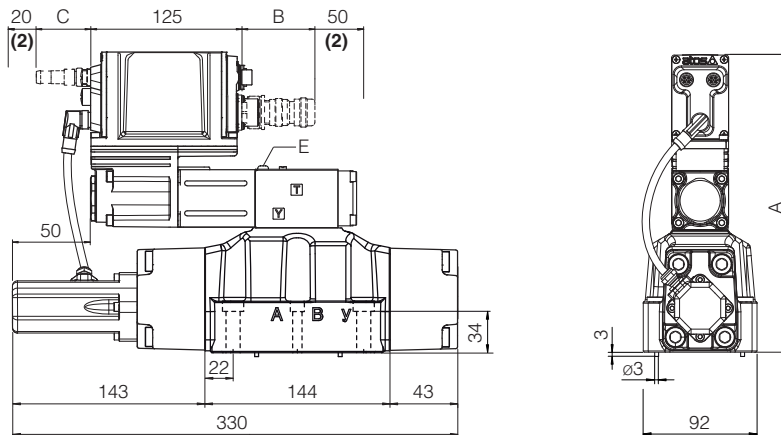

DPZO-*-2	A	B (1)	C (1)	E (air bleeding)	Mass [kg]
LEB - SN - IL	237	60	-		14,4
LEB - SN - NP	237	100	-		
LES - SN - NP, BC, BP, EH	237	100	58		
LES - SN - EW, EI, EP	252	100	58		
LES - SP, SF, SL - *	252	100	58		
Option /G	+30		-		+0,9

- (1) The indicated dimension refers to the longer connectors or Bluetooth adapter
For dimensions of connectors and Bluetooth adapter, see sections 22.6, 22.7 and 22.8
(2) Space required for connection cable and for connector removal

Note: for /B option the proportional solenoid, the LVDT transducer and the on-board digital driver are at side of port B of the main stage

DPZO-LEB-*-4

ISO 4401: 2005

DPZO-LES-*-4

Mounting surface: 4401-08-08-0-05(see table P005)

DPZO-LEB-*-4M

ISO 4401: 2005

DPZO-LES-*-4M

Mounting surface: 4401-08-08-0-05(see table P005)
ports A, B, P, T Ø 32mm

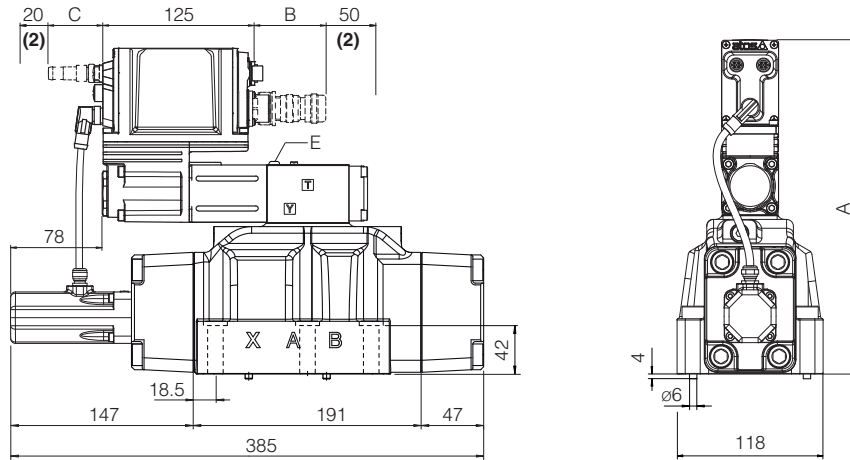

DPZO-*-4 and DPZO-*-4M	A	B (1)	C (1)	E (air bleeding)	Mass [kg]
LEB - SN - IL	266	60	-	 3	19,4
LEB - SN - NP	266	100	-		
LES - SN - NP, BC, BP, EH	266	100	58		
LES - SN - EW, EI, EP	281	100	58		
LES - SP, SF, SL - *	281	100	58		
Option /G	+30		-		+0,9

- (1) The indicated dimension refers to the longer connectors or Bluetooth adapter
For dimensions of connectors and Bluetooth adapter, see sections 22.6, 22.7 and 22.8
(2) Space required for connection cable and for connector removal

DPZO-LEB-*-6

ISO 4401: 2005

DPZO-LES-*-6

Mounting surface: 4401-10-09-0-05 (see table P005)

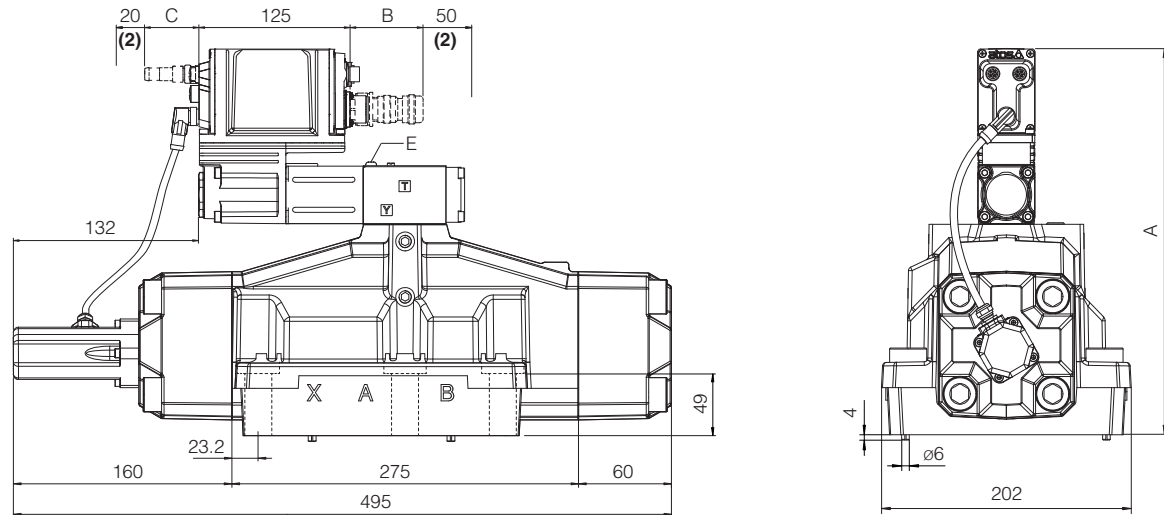

DPZO-*-6	A	B (1)	C (1)	E (air bleeding)	Mass [kg]
LEB - SN - IL	308	60	-	 3	43,4
LEB - SN - NP	308	100	-		
LES - SN - NP, BC, BP, EH	323	100	58		
LES - SN - EW, EI, EP	323	100	58		
LES - SP, SF, SL - *	323	100	58		
Option /G	+40		-		+0,9

- (1) The indicated dimension refers to the longer connectors or Bluetooth adapter
For dimensions of connectors and Bluetooth adapter, see sections 22.6, 22.7 and 22.8
(2) Space required for connection cable and for connector removal

Note: for /B option the proportional solenoid, the LVDT transducer and the on-board digital driver are at side of port B of the main stage

DPZO-LEB-*-8
DPZO-LES-*-8

ISO 4401: 2005
 Mounting surface: 4401-10-09-0-05 (see table P005)

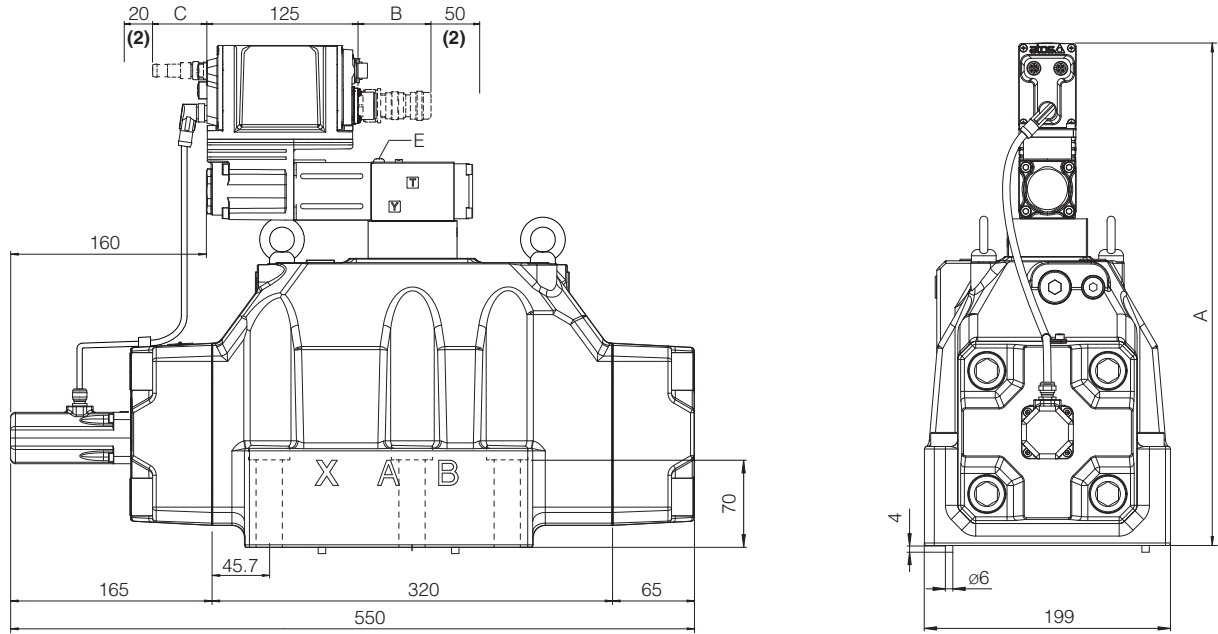

DPZO-*-8	A	B (1)	C (1)	E (air bleeding)	Mass [kg]
LEB - SN - IL	402	60	-	 3	80,4
LEB - SN - NP	402	100	-		
LES - SN - NP, BC, BP, EH	402	100	58		
LES - SN - EW, EI, EP	417	100	58		
LES - SP, SF, SL - *	417	100	58		
Option /G	+40		-		+0,9

- (1) The indicated dimension refers to the longer connectors or Bluetooth adapter
 For dimensions of connectors and Bluetooth adapter, see sections 22.6, 22.7 and 22.8
 (2) Space required for connection cable and for connector removal

Note: for /B option the proportional solenoid, the LVDT transducer and the on-board digital driver are at side of port B of the main stage

27 FASTENING BOLTS AND SEALS

Type	Size	Fastening bolts	Seals
DPZO	1 = 10	4 socket head screws M6x40 class 12.9 Tightening torque = 15 Nm	5 OR 2050 Diameter of ports A, B, P, T: Ø 11 mm (max) 2 OR 108 Diameter of ports X, Y: Ø = 5 mm (max)
	2 = 16	4 socket head screws M10x50 class 12.9 Tightening torque = 70 Nm 2 socket head screws M6x45 class 12.9 Tightening torque = 15 Nm	4 OR 130 Diameter of ports A, B, P, T: Ø 20 mm (max) 2 OR 2043 Diameter of ports X, Y: Ø = 7 mm (max)
	4 = 25	6 socket head screws M12x60 class 12.9 Tightening torque = 125 Nm	4 OR 4112 Diameter of ports A, B, P, T: Ø 24 mm (max) 2 OR 3056 Diameter of ports X, Y: Ø = 7 mm (max)
	4M = 27	6 socket head screws M12x60 class 12.9 Tightening torque = 125 Nm	4 OR 3137 Diameter of ports A, B, P, T: Ø 32 mm (max) 2 OR 3056 Diameter of ports X, Y: Ø = 7 mm (max)
	6 = 32	6 socket head screws M20x80 class 12.9 Tightening torque = 600 Nm	4 OR 144 Diameter of ports A, B, P, T: Ø 34 mm (max) 2 OR 3056 Diameter of ports X, Y: Ø = 7 mm (max)
	8 = 35	6 socket head screws M20x100 class 12.9 Tightening torque = 600 Nm	4 OR 156 Diameter of ports A, B, P, T: Ø 50 mm (max) 2 OR 3056 Diameter of ports X, Y: Ø = 9 mm (max)

28 RELATED DOCUMENTATION

FS001	Basics for digital electrohydraulics	K800	Electric and electronic connectors
FS500	Digital proportional valves with p/Q control	P005	Mounting surfaces for electrohydraulic valves
FS630	Digital proportional valves with integral axis controller	QB320	Quickstart for LEB valves commissioning
FS900	Operating and maintenance information for proportional valves	QF320	Quickstart for LES valves commissioning
FY100	Safety proportional valves - option /U	Y010	Basics for safety components
FY200	Safety proportional valves - option /K	E-MAN-RI-LEB	TEB/LEB user manual
GS500	Programming tools	E-MAN-RI-LES	TES/LES user manual
GS510	Fieldbus	E-MAN-RI-LES-S	TES/LES with p/Q control user manual
GS520	IO-Link interface		