



4/3, 4/2 and 3/2 Directional Valve with Wet-pin AC or DC Solenoid

2.12

Type WE 6...L6X

Size (NG) 6
Up to 350 bar
Up to 80L/min



Contents

Function and configurations	02
Ordering code	03
Symbols	04
Characteristic curves	04
Technical data	05
Electric data	05
Performance limits	06-07
Unit dimensions	08-09

Features

- Direct operated directional solenoid valve, standard version
- Porting pattern according to DIN 24 340 form A, ISO 4401 and CETOP-RP 121 H
- Wet-pin AC or DC solenoids with detachable coil
- Pressure-tight chamber needs not to be opened for a coil change
- Electrical connection as individual or central connection

Function and configurations

Type WE valves are solenoid operated directional spool valves. They control the start, stop and direction of flow.

The directional control valves consist of housing (1), one or two solenoids (2), the control spool (3), and one or two return springs (4).

In the de-energized condition the control spool (3) is held in the neutral or initial position by means of return springs (4) (except for impulse spools). The control spool (3) is actuated via wet pin solenoids (2).

To ensure proper operation, care must be taken that the pressure chamber of the solenoid is filled with oil.

The control spool(3) is moved to the expected position by solenoid(2) and pushing rod(5). This gives free-flow from P to A and B to T or P to B and A to T.

When solenoid (2) is de-energized, the control spool (3) is returned to its initial position by means of the return springs (4).

The solenoids may also control the control spool (3) by an optional override button(6) under the de-energized condition.

Type 4WE 6.. L6X/O...

(only for symbols A, C and D)

This version refers to directional valves with two spool positions and two solenoids without detent. In the de-energized condition, there is no defined spool position.

Type 4WE 6.. L6X/OF...

(impulse spool, only for symbols A, C and D)

This version refers to directional valves with two spool positions, two solenoids and a detent. Due to this, both spool positions are positively held, and a permanent energization of the solenoid is not required.

Throttle insert (type 4WE 6..L6X/.../B..)

The use of throttle inserts is required, due to prevailing operating conditions, flows can occur during switching processes that exceed the performance limit of the valve. They are inserted in the P-channel of the directional valve.

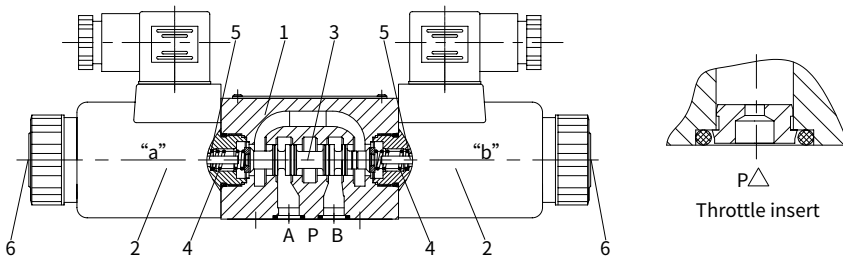

Ordering code

	WE	6	- L6X /				/			*
3 ways (For spool A and B)	= 3									
4 ways	= 4									
Directional valve with wet pin solenoids										
Nominal size 6	=6									
Symbols e.g. C, E etc.										
Series L60 to L69 (L60 to L69: unchanged installation and connection dimensions)	=L6X									
With spring return	= No code									
Without spring return	=O									
Without spring return, and with detent	=OF									
Standard solenoid	=E									
Large-scope solenoid (Only for 12V and 24V)	=N									
24V DC	=G24									
220V AC 50/60 Hz	=W220									
Plug rectification 220V	=W220R									
110V AC 50/60 Hz	=W110									
Other voltage see technical data										
With manual override button	= N									

Further details in clear text

No code=Without locating hole
/60= With locating hole
/62=With locating pin hole
ISO 8752-3×8-St

No code = NBR seals
V = FKM seals

No code = Without throttle insert
B08 = Throttle Φ0.8 mm
B10 = Throttle Φ1.0 mm
B12 = Throttle Φ1.2 mm
B15 = Throttle Φ1.5 mm
B20 = Throttle Φ2.0 mm
B25 = Throttle Φ2.5 mm
B30 = Throttle Φ3.0 mm

Z4 = square plugs
(not applicable for the integer)

Z5L = square plugs with lamps

Z5L2 = With light and protect the diodes

K4 = DIN4365 sockets without plugs

K7 = Deutsch connector assembly, without plugs ¹⁾

DL = Central connection with LED lamp (M22×1.5 interface)

Note:

1) K7 Deutsch connector assembly
Only for 12V and 24V.

Symbols

<p>Transition position</p> <p>Spool valve symbols</p>	<p>Transition position</p> <p>Spool valve symbols</p>	<p>Transition position</p> <p>Spool valve symbols</p>	<p>Transition position</p> <p>Spool valve symbols</p>	<p>Transition position</p> <p>Spool valve symbols</p>	<p>Transition position</p> <p>Spool valve symbols</p>
=A9 (Port T as drain port) =B9 (Port T as drain port) =C =D =D9 =Y9 =DE =DJ =LF	=B (Port T as drain port) =Y =YE =JB2 =YJ =G3 =GE =M2.../0	=E1 =M2 =E10	=E1 =M2 =E10	=E1 =M2 =E10	=E1 =M2 =E10

Notes: Spool symbols A9, B9, D9, Y9 are only for type without .../O... and .../OF... and are only used as pilot valves

¹⁾ Example: If solenoid is fixed at position 'a', the ordering code is...EA

Characteristic curves

(Measured at $\vartheta_{oil} = 40^\circ\text{C} \pm 5^\circ\text{C}$, using HLP46)

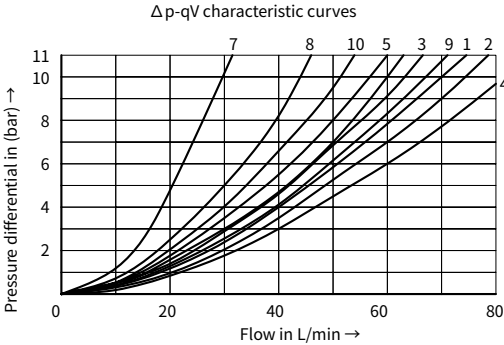

- 7 Symbol "R" in switched positions B → A
- 8 Symbol "G" and "T" in neutral position P → T
- 9 Symbol "H" in neutral position P → T

Spool symbol	Flow direction			
	P to A	P to B	A to T	B to T
A, B	3	3	-	-
C	1	1	3	1
D, Y	5	5	3	3
E	3	3	1	1
F	1	3	1	1
T	10	10	9	9
H	2	4	2	2
J, Q	1	1	2	1
L	3	3	4	9
M	2	4	3	3
P	3	1	1	1
R	5	5	4	-
V	1	2	1	1
W	1	1	2	2
U	3	3	9	4
G	6	6	9	9

Technical data

Fixing position			Optional
Environment temperature range °C			-30 to +50 (NBR seal)
			-20 to +50 (FKM seal)
Weight	Single solenoid	kg	1.5
	Double solenoids	kg	2.0
Max. operating pressure	Port A,B,P	bar	350
	Port T	bar	210 (DC), 160 (AC), when the operating pressure exceed the permission value, port T must be used as drain port for spool symbol A and B
Max. flow-rate		L/min	80 (DC), 60 (AC)
Flow cross section		mm ²	for symbol Q 6% of nominal cross section
(switching neutral position)		mm ²	for symbol W 3% of nominal cross section
Fluid			Mineral oil suitable for NBR and FKM seal
			Phosphate ester for FKM seal
Fluid temperature range °C			-30 to +80 (NBR seal)
			-20 to +80 (FKM seal)
Viscosity range		mm ² /s	2.8 to 500
Degree of contamination			Maximum permissible degree of fluid contamination: Class 9. NAS 1638 or 20/18/15, ISO4406

Electric data

Type of voltage			DC	AC
Usable voltage		V	12,24,28 ¹⁾ ,48,96,110,205,220	110, 127, 220
Permissible voltage (deviation)		%	Standard solenoid: +10 ~ -15 Large-scope solenoid: +20~-30	
Power consumption		W	Standard solenoid: 30 Large-scope solenoid: 32	
Holding power		VA	-	50
Making capacity		VA	-	220
Duty			Continuous working	
Switching time to ISO 6403	ON	ms	25 to 45	10 to 20
	OFF	ms	10 to 25	15 to 40
Switched frequency		times/h	to 15000	to 7200
Type of protection to DIN 40050			IP65 (Z4, Z5L plug), IP67 (K7 Deutsch)	
Max. coils temperature		°C	+150	+180

Caution: When connecting wires, properly connect the PE conductor (PE \perp).

(For other type voltage please consult us.)

Performance limits (Measured at $\theta_{oil}=40^{\circ}\text{C} \pm 5^{\circ}\text{C}$, using HLP46)

The specified switching performance limits are valid with two directions of flow (e.g. from P to A and simultaneous return flow from B to T).

Due to the flow forces acting within the valve, the permissible switching performance limit can be significantly lower with only one direction of flow (e.g. from P to A, with port B being closed)!

The switching performance limit was determined with the solenoid at operating temperature, at 15 % under-voltage and without tank pre-loading.

Solenoid DC		Solenoid AC-50Hz		Solenoid AC-60Hz	
Curve	Spool symbol	Curve	Spool symbol	Curve	Spool symbol
1	A, B ₁	11	A, B ₁	19	A, B ₁
2	V	12	V	20	V
3	A, B	13	A, B	21	A, B
4	F, P	14	F, P	22	F, P
5	J	15	G, T	23	G, T
6	G, H, T	16	H	24	J, L, U
7	A/O, A/OF, L, U	17	A/O, A/OF, C/O,	25	A/O, A/OF, Q, W
8	C, D, Y		C/OF, D/O, D/OF	26	C, D, Y
9	M		E, J, L, M	27	H
10	E, R ₂₁ , C/O, C/OF	18	Q, R ₂₁ , U, W	28	C/O, C/OF, D/O
	D/O, D/OF, Q, W		C, D, Y		D/OF, M, R, E, R ₂₁

Notes: ¹⁾ With manual override; ²⁾ Return flow from actuator to tank.

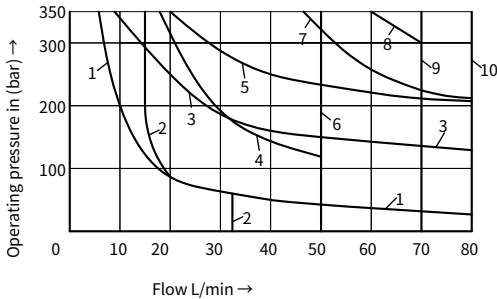

Solenoid DC	
Curve	Solenoid voltage(V)
1 to 10	12, 24, 48, 96, 205

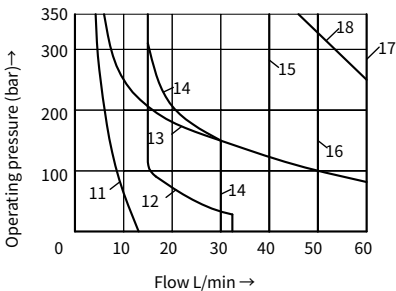

Solenoid AC		
Curve	Solenoid voltage	
11 to 18	W110	110V, 50Hz
	W127	127V, 50Hz
	W230	230V, 50Hz

Performance limits (Measured at $\vartheta_{oil} = 40^{\circ}C \pm 5^{\circ}C$, using HLP46)

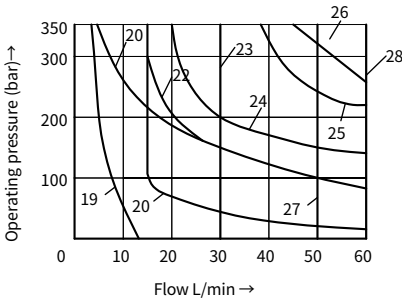

Solenoid AC		
Curve	Solenoid voltage	
19 to 28	W110	110V, 60Hz
	W230	230V, 60Hz

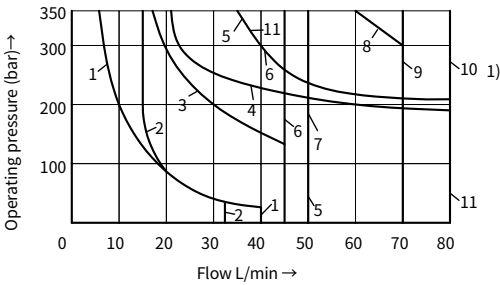

Solenoid DC	
Curve	Solenoid voltage
1 to 10 ₁₎	110, 180

Curve	Spool symbol	Curve	Spool symbol	Curve	Spool symbol
1	A,B	6	T	10 ₁₎	E, R, C/O, C/OF, D/O, D/OF, Q, W
2	V	7	H		
3	F, P	8	C,D	10 ₂₎	R, C/O, C/OF, D/O, D/OF, Q, W
4	J, L, U	9	M	11	A/O, A/OF
5	G			12	E

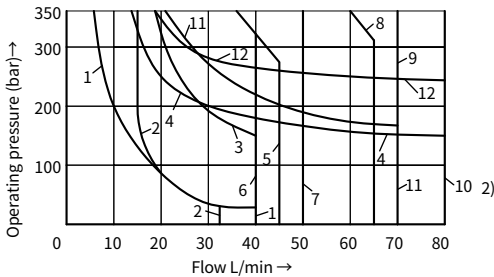

Solenoid AC	
Curve	Solenoid voltage
1 to 12, see 10 ₂₎	220

Unit dimensions

(Dimensions in mm)

Valve with DC or rectification AC solenoid

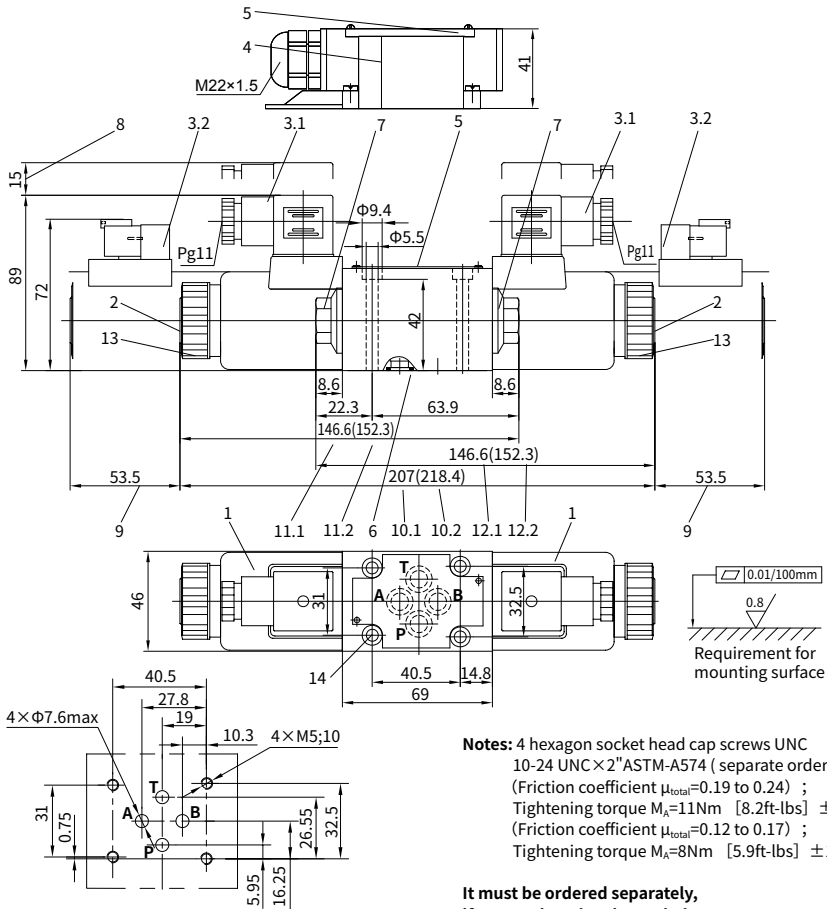

Notes: 4 hexagon socket head cap screws UNC 10-24 UNC $\times 2$ " ASTM-A574 (separate order)
 (Friction coefficient $\mu_{\text{total}}=0.19$ to 0.24) ;
 Tightening torque $M_A=1.1\text{Nm}$ [8.2ft-lbs] $\pm 15\%$
 (Friction coefficient $\mu_{\text{total}}=0.12$ to 0.17) ;
 Tightening torque $M_A=8\text{Nm}$ [5.9ft-lbs] $\pm 10\%$

It must be ordered separately, if connection plate is needed.

Type: G341/01(G1/4), G341/02 (M14 \times 1.5)
 G342/01(G3/8), G342/02 (M18 \times 1.5)
 G502/01(G1/2), G502/02 (M22 \times 1.5)

- 1 Solenoid
- 2 Manual override button
- 3.1 Plug-in connector to DIN 43 650
- 3.2 Deutsch connector assembly
- 4 Junction box with lead and light, M22 \times 1.5 interface
- 5 Nameplate
- 6 O-ring: 9.25 \times 1.78
- 7 Plug screw for valves with one solenoid
- 8 Space required to remove connector
- 9 Space required to remove coil
- 10.1 Dimension of 3-position valves, standard version
- 10.2 Dimension of 3-position valves, large-scope Type of voltage

- 11.1 Dimension of 2-position valves with solenoid at 'A', standard version
- 11.2 Dimension of 2-position valves with solenoid at 'A', large-scope Type of voltage
- 12.1 Dimension of 2-position valves with solenoid at 'B', standard version
- 12.2 Dimension of 2-position valves with solenoid at 'B', large-scope Type of voltage
- 13 Securing nut, tightening torque $M_A=4\text{Nm}$
- 14 Valve fixing screws. Hexagon socket head cap screw M5 \times 50 GB/T 70.1-10.9, Tightening torque $M_A=8.9\text{Nm}$

Unit dimensions

(Dimensions in mm)

Valve with AC solenoid

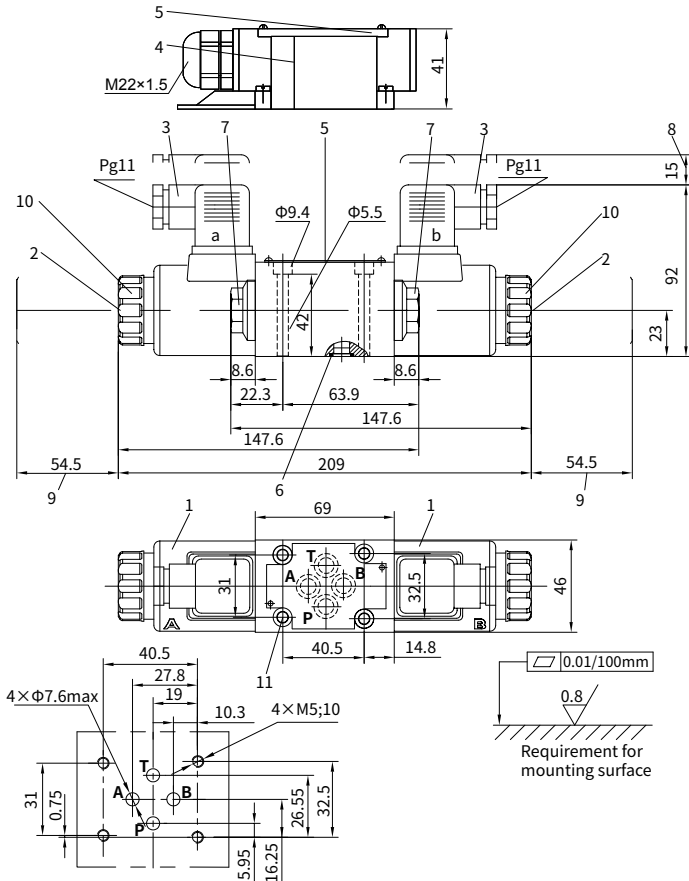

- 1 Solenoid
- 2 Manual override button
- 3 Plug-in connector to DIN 43 650 (rotatable 90°)
- 4 Junction box with lead and light, M22×1.5 interface
- 5 Nameplate
- 6 Seal rings 9.25×1.78
- 7 Plug screw for valves with one solenoid
- 8 Space required to remove connector
- 9 Space required to remove coil
- 10 Securing nut, tightening torque, $M_A=4\text{ Nm}$
- 11 Valve fixing screws. Hexagon socket head cap screw M5×50 GB/T 70.1-10.9, Tightening torque $M_A=8.9\text{ Nm}$

Notes: 4 hexagon socket head cap screws UNC 10-24 UNC×2"ASTM-A574 (separate order)
 (Friction coefficient $\mu_{\text{total}}=0.19$ to 0.24) ;
 Tightening torque $M_A=11\text{ Nm}$ [8.2ft-lbs] $\pm 15\%$
 (Friction coefficient $\mu_{\text{total}}=0.12$ to 0.17) ;
 Tightening torque $M_A=8\text{ Nm}$ [5.9ft-lbs] $\pm 10\%$

It must be ordered separately, if connection plate is needed.

Type:
 G341/01(G1/4),G341/02 (M14×1.5)
 G342/01(G3/8),G342/02(M18×1.5)
 G502/01(G1/2),G502/02(M22×1.5)

China

+86 400 101 8889

America

+01 630 995 3674

Germany

+49 172 3683463

Japan

+81 03 6809 1696



© This brochure can be reproduced, edited, reproduced or transmitted electronically without the authorization of Hengli Hydraulic Company. Due to the continuous development of the product, the information in this brochure is not specific to the specific conditions or applicability of the industry, thus, Hengli does not take any responsibility for any incomplete or inaccurate description.



4/3, 4/2 and 3/2 Directional Valve with Wet-pin AC or DC Solenoid

2.13

Type WE 10...L3X

Size 10
Up to 315 bar
Up to 120L/min



Contents

Function and configuration s	02
Ordering code	03
Symbols	04
Characteristic curves	04
Technical data	05
Electric data	05
Performance limits	06
Unit dimensions	07-08

Features

- Direct operated directional solenoid valve, standard version
- Porting pattern according to DIN 24 340 form A, ISO 4401 and CETOP-RP 121 H
- Wet pin DC or AC solenoids with detachable coil
- Pressure-tight chamber needs not to be opened for a coil change

Function and configuration

Type WE valves are solenoid operated directional spool valves. They control the start, stop and direction of flow.

The directional control valves consist of housing (1), one or two solenoids (2), the control spool (3), and one or two return springs (4).

In the de-energized condition the control spool (3) is held in the neutral or initial position by means of return springs (4) (except for pulse spools). The control spool (3) is actuated via wet pin solenoids (2).

To ensure proper operation, care must be taken that the pressure chamber of the solenoid is filled with oil.

The control spool(3) is moved to the expected position by solenoid(2) and pushing rod(5), and this gives free-flow from P to A and B to T or P to B and A to T.

When solenoid (2) is de-energized, the control spool (3) is returned to its neutral position by means of the return springs (4).

The solenoids may also control the control spool (3) by an optional override button(6) under the de-energized condition.

For application in voltage pulsation, solenoids with large scope voltage are recommended.

For application in high protective grade, waterproof plug should be used.

Type 4WE10.. L3X/O...

(Only for symbols A, C and D)

This Type is a 2-position directional valve with 2 solenoids without detents. The spool position, when the solenoids are de-energised, is not defined..

Type 4WE10.. L3X/OF...

(Impulse spool, only for symbols A, C and D)

This Type is a 2-position directional valve with 2 solenoids and detents. Hence, when the solenoids are de-energized, the spool is held in the detented position then the solenoids do not need to be continuously energised.

Throttle insert (type 4WE10...L3X/.../B..)

The use of a throttle insert is required if, due to the operating conditions, flows can occur during the switching process which are larger than the performance limits of the valve allow.

The orifice is to be inserted into the P channel of the directional valve.

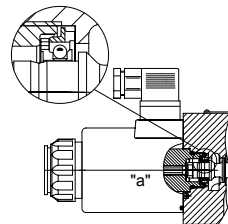
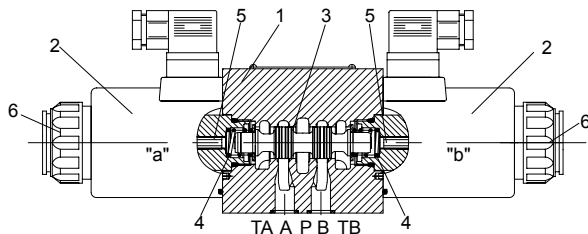

Type 4WE10.. L3X/OF...
(Impulse spool)

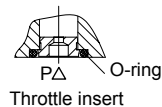

Ordering code

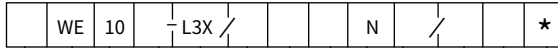

3 ways = 3
(For spool A and B)
4 ways = 4

Directional valve with wet pin solenoids

Nominal size 10 =10

Symbols e.g. C, E etc.

Series L30 to L39 =L3X
(L30 to L39: unchanged installation and connection dimensions)

With spring return = No code
Without spring return = O
Without spring return, and with detent = OF

Standard solenoid =C
Large-range solenoid (Only for K4 24V DC) =N

24V DC =G24
220V AC 50/60 Hz =W220
Plug rectification 220V =W220R
110V AC 50/60 Hz =W110
Other voltage see next page

With manual override button = N

Further details in clear text

No code = NBR seals
V = FKM seals

No code = Without throttle insert
B08 = Throttle Φ 0.8 mm
B10 = Throttle Φ 1.0 mm
B12 = Throttle Φ 1.2 mm
B15 = Throttle Φ 1.5 mm
B20 = Throttle Φ 2.0 mm
B25 = Throttle Φ 2.5 mm
B30 = Throttle Φ 3.0 mm

Z4 = square plugs (not applicable for the integer)
Z5L = square plugs with lamps
Z5L2=With light and protect the diodes
K4 = DIN4365 sockets without plugs
K7 = Deutsch connector assembly, without plugs¹⁾
DL = Central connection with indicator lamp (M22×1.5 interface)

Note: 1) K7 Deutsch connector assembly Only for 12V and 24V.

Symbols

Transition position

Spool valve symbols

Transition position

Spool valve symbols

¹⁾ Spool symbols B9,Y9 are only for type without .../O...and .../OF... .

²⁾ Example: If solenoid is fixed at position 'a', the ordering code is ...EA

Characteristic curves

(Measured at $\vartheta_{oil} = 40^{\circ}\text{C} \pm 5^{\circ}\text{C}$, using HLP46)

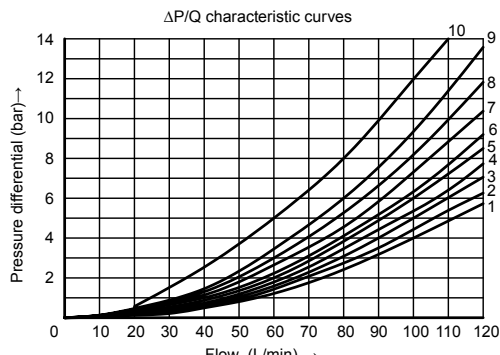

Open position	P to A	B to A	A to T	P to T	
R	-	9	-	-	
Open position	P to A	P to B	B to T	A to T	P to T
F	4	-	-	9	9
P	-	5	8	-	10
G,T	-	-	-	-	9
H	-	-	-	-	3

Spool symbol	Flow direction			
	P to A	P to B	A to T	B to T
A,B	3	3	-	-
C	3	3	4	5
D,Y	5	5	6	6
E	1	1	4	4
F	2	3	7	4
G	3	3	6	7
H	1	1	6	7
J	1	1	3	3
L	2	2	3	5
M	1	1	4	5
P	4	2	5	7
Q	1	2	1	3
R	3	6	4	-
T	3	3	6	7
U,V	2	2	3	3
W	2	2	4	5

Technical data

Fixing position			Optional	
Environment temperature range		°C	-30 to +50 (NBR seal)	
			-20 to +50 (FKM seal)	
Weight			Independently wiring	central monitoring station
	Single solenoid	kg	4.3(DC), 3.5(AC)	4.4(DC), 3.6(AC)
	Double solenoids	kg	5.9(DC), 4.3(AC)	6.0 (DC), 4.4(AC)
Max.operating pressure	Port A,B,P	bar	315	
	Port T	bar	210 (DC),160 (AC), when the operating pressure exceeds the permission value, spool symbol A and B must make the port T for draining.	
Max. flow-rate		L/min	120	
Flow cross section (switching neutral position)	Version V	mm ²	11(A/B to T), 10.3(PtoA/B)	
	Version W	mm ²	2.5(A/B to T)	
	Version Q	mm ²	5.5(A/B to T)	
Fluid		Mineral oil suitable for NBR and FKM seal		
		Phosphate ester for FKM seal		
Fluid temperature range		°C	-30 to +80 (NBR seal)	
			-20 to +80 (FKM seal)	
Viscosity range		mm ² /s	2.8 to 500	
Degree of contamination		Maximum permissible degree of fluid contamination: Class 9. NAS 1638 or 20/18/15, ISO4406		

Electric data

Type of voltage		DC		AC
Available voltage	V	12,24,28 ¹⁾ ,48,96,110,205,220		110,127,220
Voltage tolerance (nominal voltage)		%	Standard solenoid: +10~ -15 large-scope solenoid: +20~-30	
Power consumption		W	Standard solenoid: 35 large-scope solenoid: 42	
Holding power	VA	-	50	
Making capacity	VA	-	550	
Duty		Continuous working		
Switching time to ISO 6403	ON	ms	45 to 60	15 to 25
	OFF	ms	20 to 30	20 to 30
Switched frequency		times/h	to 15000	to 7200
Type of protection to DIN 40050		IP65(Z4,Z5L plug), IP67 (K7 Deutsch)		
Max. coils temperature		°C	+150	+180

Caution: When connecting wires, properly connect the PE conductor (PE $\frac{1}{2}$).

(For other type voltage please consult us.)

Performance limits (Measured at $\theta_{oil}=40^{\circ}C \pm 5^{\circ}C$, using HLP46)

The performance limits shown are valid when the valve is used with two directions of flow (e.g. from P to A with simultaneous return flow from B to T).

Due to the flow forces occurring within the valves, the permissible switching performance limits can be significantly lower with only one direction of flow (e.g. from P to A and port B blocked)! (For these applications, please consult us.)

The performance limit was determined with the solenoids at their operating temperature, 15% under voltage and with no pre-loading of the tank.

Valves with solenoid DC

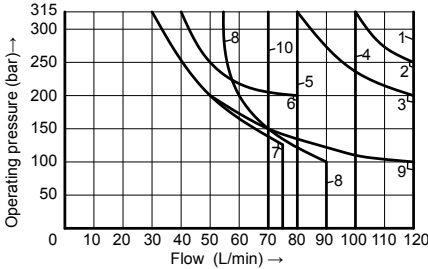

Valves with solenoid AC

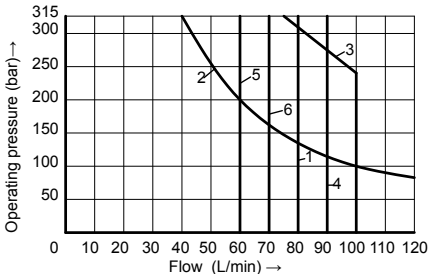
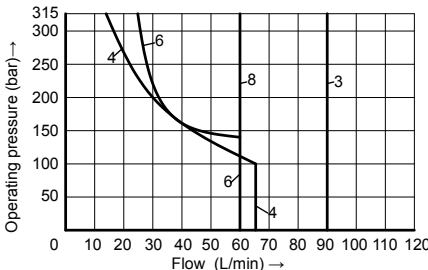
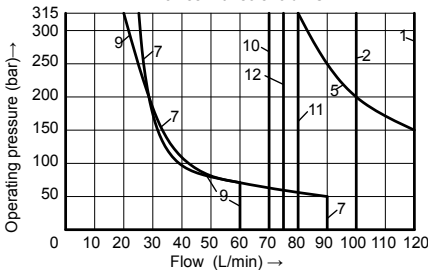

Curve	Spool symbol	Curve	Spool symbol
1	C, C/O, C/OF; D, D/O, D/OF; Y, M	5 ₁₎	R, L ₂₎ , U ₂₎
		6	G
2	E	7	T
3	A/O, A/OF; L, U, J, Q, W	8	F, P
		9	A, B
4	H	10	V

Notes: 1) Return flow (independent of area ratio);
2) Only suitable for neutral position

Curve	Spool symbol	Curve	Spool symbol
1	C, C/O, C/OF; D, D/O, D/OF; Y	6	G
		7	F, P
		8	V
2	E, L, U, Q, W	9	T
3	M	10	H
4	A, B	11	R
5	A/O, A/OF, J	12 ₁₎	L, U

Notes:
1) Only suitable for neutral position
48V 50Hz, 110V 50Hz, 127V 50Hz,
220V 50Hz, 230V 60Hz

Curve	Spool symbol	Curve	Spool symbol
1	C, C/O, C/OF; D, D/O, D/OF; Y	3	E
		4	M
		5	V
2	A/O, A/OF	6	H

48V 60Hz, 110V 60Hz, 127V 60Hz, 220V 60Hz

Unit dimensions

(Dimensions in mm)

Valve with DC or rectification AC solenoid

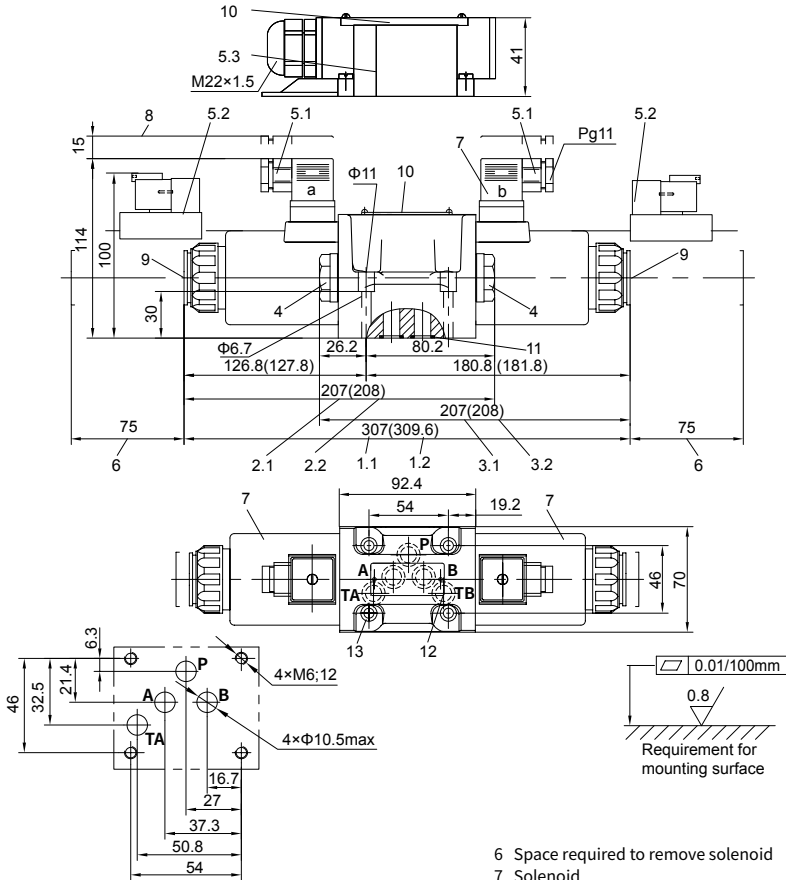

- 1.1 Dimension of 3-position, standard version
- 1.2 Dimension of 3-position, large-scope
Type of voltage
- 2.1 Dimension of 2-position with solenoid at 'A', standard version
- 2.2 Dimension of 2-position with solenoid at 'A', large-scope Type of voltage
- 3.1 Dimension of 2-position with solenoid at 'B', standard version
- 3.2 Dimension of 2-position with solenoid at 'B', large-scope Type of voltage
- 4 Plug for valves with one solenoid
- 5.1 Plug-in connector to DIN 43 650 (rotatable 90 °)
- 5.2 Deutsch connector assembly
- 5.3 Junction box with lead and light, M22×1.5 interface

- 6 Space required to remove solenoid
- 7 Solenoid
- 8 Space required to remove Plug-in connector
- 9 Fault inspection override 'N' button
- 10 Nameplate
- 11 O-ring 12×2
- 12 Fix additional port TB on the manifold when necessary
- 13 Valve fixing screws:
M6×40 GB/T 70.1-10.9, Tightening torque $M_A=15.5\text{Nm}$, must be ordered separately.

It must be ordered separately, if connection plate is needed.

Type:

- G 66/01 (G 3/8), G 66/02(M18×1.5)
- G 67/01 (G 1/2), G 67/02(M22×1.5)
- G 534/01 (G 3/4), G 534/02(M27×2)

Unit dimensions

(Dimensions in mm)

Valve with AC solenoid

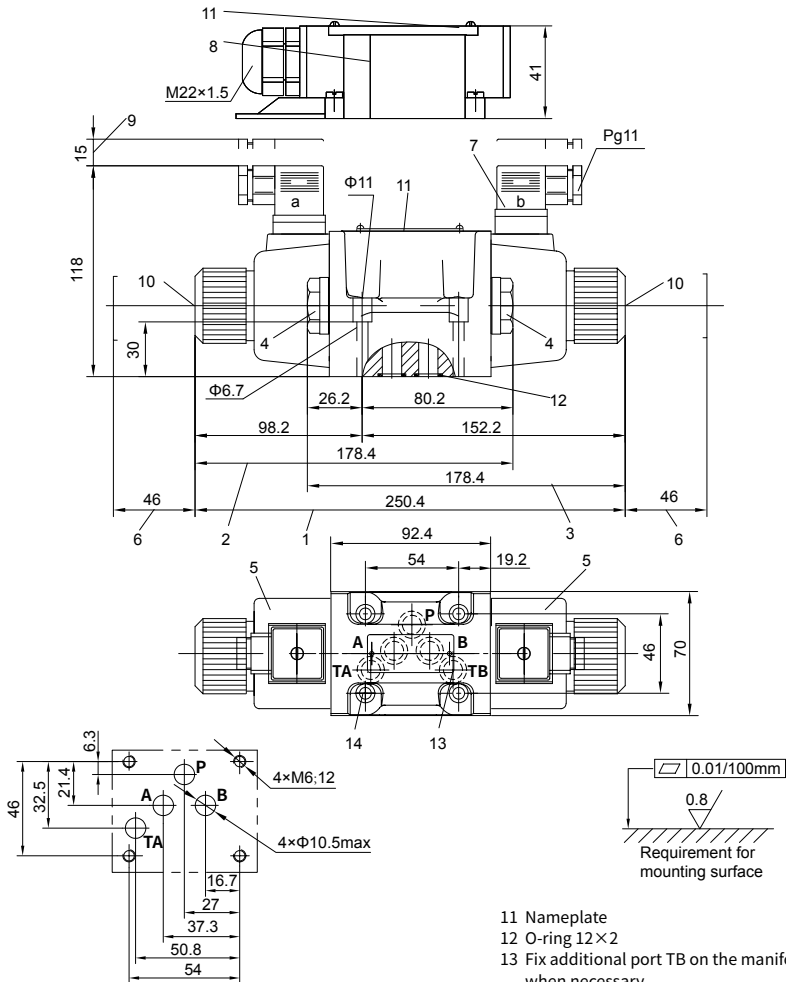

- 1 3-position valve
- 2 2-position valve with one solenoid(A,C,D,EA...)
- 3 2-position valve with one solenoid(B,Y,EB...)
- 4 Plug for valves with one solenoid
- 5 Solenoid
- 6 Space required to remove the solenoid
- 7 Plug-in connector to DIN 43 650 (Rotatable 90°)
- 8 Junction box with lead and light, M22×1.5 interface
- 9 Space required to remove Plug-in connector
- 10 Fault inspection override 'N' button

- 11 Nameplate
- 12 O-ring 12×2
- 13 Fix additional port TB on the manifold when necessary
- 14 Valve fixing screws:
M6×40 GB/T 70.1-10.9, Tightening torque
 $M_A=15.5\text{Nm}$, must be ordered separately.

It must be ordered separately, if connection plate is needed.

Type:

G 66/01 (G 3/8), G 66/02(M18×1.5)
G 67/01 (G 1/2), G 67/02(M22×1.5)
G 534/01 (G 3/4), G 534/02(M27×2)



4/3, 4/2 and 3/2 Directional Valve with Wet-pin AC or DC Solenoid

2.14

Type WE 10...L5X

Size (NG) 10
Up to 350 bar
Up to 150 L/min

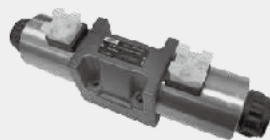

Contents

Function and configurations	02-03
Ordering code	04
Symbols	05
Technical data	06
Electrical data	06
Characteristic curves	07
Performance limits	07
Unit dimensions	08

Features

- Direct operated directional spool valve with solenoid operation
- Porting pattern according to DIN 24 340 Form A, ISO 4401, and CETOP-RP121H
- Wet-pin DC solenoids with detachable coil (AC voltages possible via a rectifier)
- Solenoid coil can be rotated through 90°
- The coil can be replaced without opening the pressure-tight chamber
- Adjustable spool switching time, optional

Function and configuration

WE10-L5X directional valves are solenoid operated directional spool valves. They control the start, stop and direction of flow with the additional option of adjusting the spool switching time.

These directional valves basically consist of the housing (1), one or two solenoids (2), the control spool (3), as well as one or two return springs (4).

In de-energized condition, the control spool (3) is held in the central position or in the initial position by the return springs (4) (except for valves without spring "O").

If the wet-pin electronic solenoid (2) is energized, the control spool (3) moves out of its rest position into the required end position. In this way, the required direction of flow according to the selected symbol is released. After the electronic solenoid (2) has been switched off, the control spool (3) is pushed back into its central position or into its initial position (except for valves with "OF" detent and valves without type "O" spring). A manual override (6) allows for the manual switching of the valve without solenoid energization.

To ensure proper functioning, make sure that the pressure chamber of the solenoid is filled with oil.

Adjustable spool switching time (only with DC solenoids)

The optional installation of a throttle screw (7) or orifice (8) - see below - offers the possibility of increasing the switching time to 100ms or more for WE10-L5X series of 5-chamber directional valves. The switching time is influenced by factors such as pressure, flow rate and oil viscosity, depending on the situation of installation. When the main spool (3) is in the neutral or initial position, the spring chambers at both sides are filled with oil when reversing the spool, the oil in the spring chamber flows through the connecting channel (9) to move the spool forward. The adjustment time can be adjusted according to actual needs by limiting the connection channel (9) (such as screwing in the throttle screw or installing the orifice to reduce the overcurrent area).

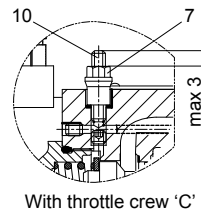
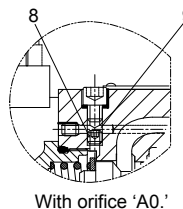
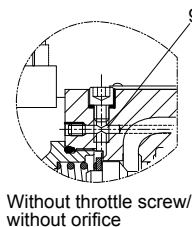
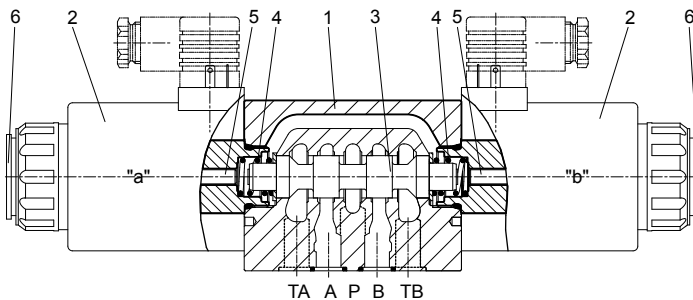

Function and configuration

Type WE10.L5X/O...

(only possible with symbols A, C and D)

This version is a directional valve with 2 switched positions and 2 solenoids without detent. There is no defined spool position in the de-energized condition.

Type WE10.L5X/OF...(Impulse spool)

(only possible with symbols A, C and D)

This version is a directional valve with 2 detented switched positions and 2 solenoids. Thus, the spool is held in the last switched position, permanent energization of the solenoid is not required.

Throttle insert

(Type 4WE10.L5X/.../B...)

The use of a throttle insert is required, due to the operating conditions. Flows can occur during the switching process which are larger than the performance limits of the valve allow.

The orifice is to be inserted into the P channel of the directional valve.

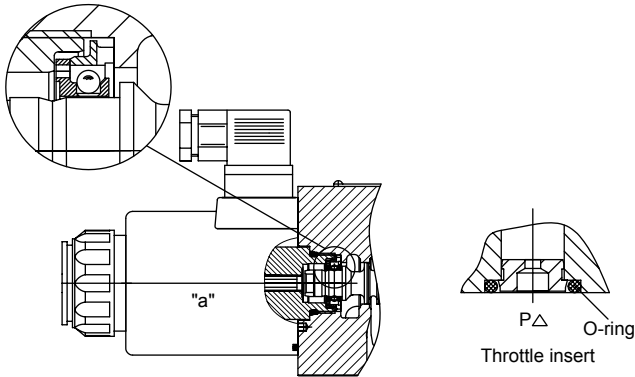

Type:WE10.L5X/OF .. (Impulse spool)

Ordering code



3 work ports (Symbol A, B) = 3 4 work ports = 4	WE	10	L5X	/	N	/				
Solenoid valve										
Nominal size 10		=10								
Symbols										
Series L50 to L59 (L50 to L59: unchanged installation and connection dimensions)			=L5X							
With spring return			= No code							
Without spring return			= O							
Without spring return with detent			= OF							
High-performance solenoid			= E							
12VDC			= G12							
24VDC			= G24							
With manual override			=N							
Square plug			= Z4							
Square plug with indicator light			= Z5L							
Without mating connector, with DT04-2P connector			= K7							
Without mating connector, with connector according to DIN EN 175301-803			= K4							

Standard= No code
 T06= Minimum
 (to be selected in case of
 reduced leakage → higher
 level of oil cleanliness
 recommended)
 T12= Increased
 (to be selected in case of a
 hydraulic fluid/environment
 temperature difference > 25 K
 → increased internal leakage)

No code= NBR seals
 V = FKM seals

No code= Without throttle insert
 B08= Throttle φ0.8 mm
 B10= Throttle φ1.0 mm
 B12= Throttle φ1.2 mm
 B15= Throttle φ1.5 mm
 B20= Throttle φ2.0 mm
 B25= Throttle φ2.5 mm
 B30= Throttle φ3.0 mm

No code= Without switching
 time adjustment
 C = With throttle screw
 A06= Throttle φ0.6 mm
 A08= Throttle φ0.8 mm
 A10= Throttle φ1.0 mm

Symbol

Transition position

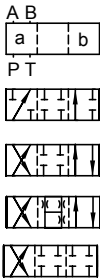
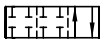
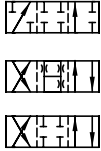
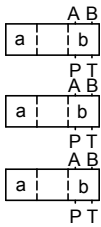

Spool valve symbol

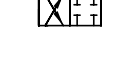
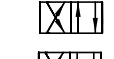
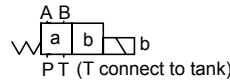
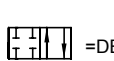
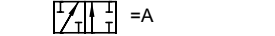
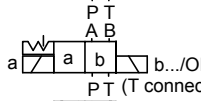
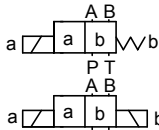

Transition position

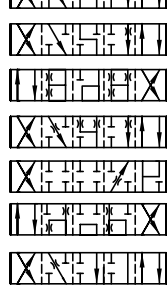
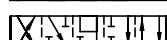
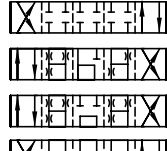
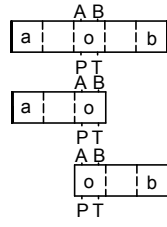

Spool valve symbol

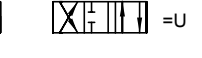
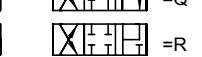
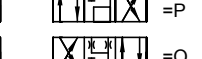
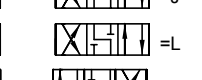
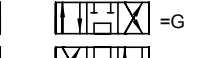
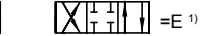
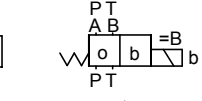
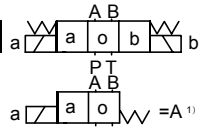

¹⁾ Example: Spool E with switched position "a".Ordering detail ..EA..

02

Technical data

Fixing position		Optional
Ambient temperature range		°C
		- 30 to + 50 (with NBR seals)
		- 20 to + 50 (with FKM seals)
Weight	Valve with 1 solenoids	kg
	Valve with 2 solenoids	kg
		4.3 (DC)
		5.9 (DC)
Max.operating pressure	Port A,B,P	bar
	Port T	bar
		350
		210 (DC), With symbols A and B, port T must be used as a drain port, if the operating pressure is higher than the permissible tank pressure.
Maximum flow		L/min
		150
Pressure fluid		Mineral oil (HL, HLP) to DIN 51 524, suitable for NBR and FKM
		Phosphate ester, suitable for FKM
Pressure fluid temperature range		°C
		- 30 to + 80 (with NBR seals)
		- 20 to + 80 (with FKM seals)
Viscosity range		mm ² /s
		2.8 to 500
ISO code cleanliness class		Maximum permissible degree of contamination of the pressure fluid is to ISO 4406 (C) class 20/18/15

Electrical data

Voltage type		DC
Available voltage		V
		12, 24
Voltage tolerance (nominal voltage)		%
		Super performance solenoid: +10 ~ -15
Power consumption		W
		39
Duty		Continuous
Switching time to ISO 6403 (without switching time adjustment)	ON	ms
	OFF	ms
		45 to 60
		20 to 30
Switched frequency		cycles/h
		Up to 15000
Protection to DIN 40 050		Z4, Z5L, K4:IP65; K7:IP67
Maximum coil temperature		°C
		+150

When connecting the electrics, the protective conductor (PE \perp) must be connected according to the relevant regulations.

Note:

The solenoid coils must not be painted. Actuation of the manual override is only possible up to a tank pressure of approx. 50 bar [725 psi]. The simultaneous actuation of 2 solenoids of one valve must be ruled out!

Characteristic curves (Measured with HLP46, $\vartheta_{oil} = 40^\circ\text{C} \pm 5^\circ\text{C}$ [$104 \pm 9^\circ\text{F}$])

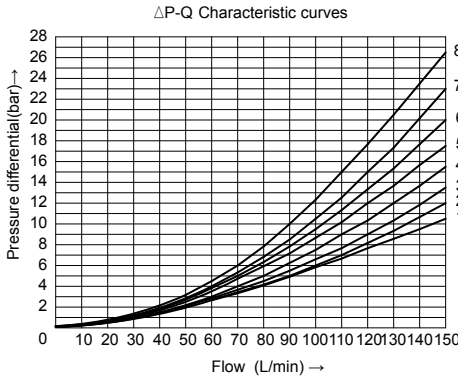

Spool symbol	Flow direction				
	P to A	P to B	A to T	B to T	P to T
A	4	4	-	-	-
B	4	5	-	-	-
C, J, Y, YH	2	3	5	7	-
D	2	2	5	7	-
E	3	3	6	7	-
F	1	3	3	8	4
G	4	5	6	8	7
H	1	1	6	8	7
L	3	3	5	7	-
P	3	1	5	6	5
R	3	4	5	6	-
U	2	2	5	7	-
DE	3	-	-	6	-
YE	-	3	6	-	-

Performance limits (Measured with HLP46, $\vartheta_{oil} = 40^\circ\text{C} \pm 5^\circ\text{C}$ [$104 \pm 9^\circ\text{F}$])

Due to the flow forces acting within the valves, the admissible performance limits may be considerably lower with only one direction of flow (e.g. from P to A while port B is blocked)!

In such cases of application, please consult us! The switching performance limit was established while the solenoids were at operating temperature, at 15% undervoltage and without tank preloading.

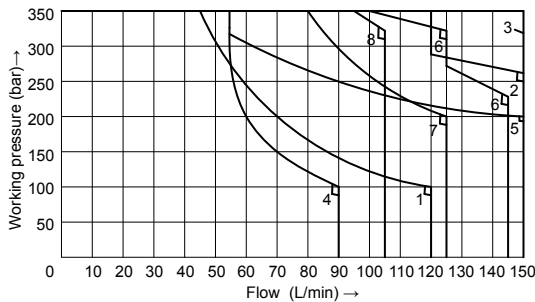

Curve	Symbol
1	A, B
2	C, D, Y, YH
3	E
4	F, P
5	G
6	H, L, U
7	J
8	R

Unit dimensions

(Dimensions in mm)

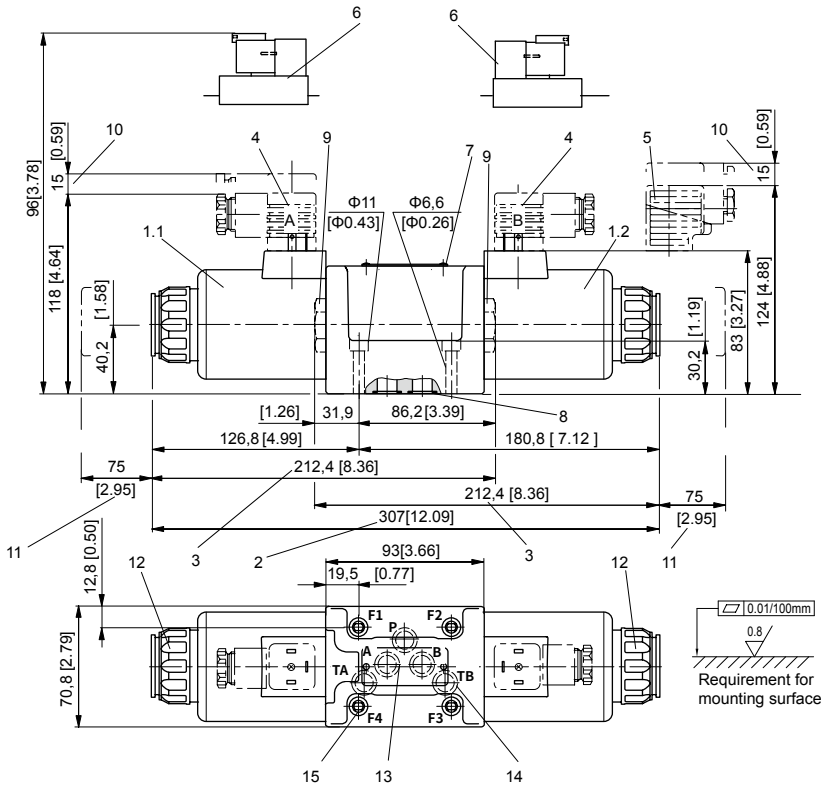

- 1.1 Solenoid "a"
 - 1.2 Solenoid "b"
 - 2 Dimension of 3-position valves
 - 3 Dimension of 2-position valves
 - 4 Connector without indicator light according to DIN EN 175301-803
 - 5 Connector with indicator light according to DIN EN 175301-803
 - 6 DT04-2P Deutsch connector
 - 7 Name plate
 - 8 Identical seal rings for ports A, B, P, TA and TB
 - 9 Plug screw for valves with one solenoid
 - 10 Space required to remove connector
 - 11 Space required to remove coil
 - 12 Securing nut, tightening torque $M_A = 6+2 \text{ Nm}$ [4.43 +1.48 ft-lbs]
 - 13 Porting pattern according to ISO 4401-05-04-0-05 and DIN 24340 A10
 - 14 TB can be used in connection with separately produced bore
 - 15 Valve fixing screws:
4 hexagon socket head cap screws, metric ISO 4762-M6×40-10.9
Tightening torque $M_A = 15.5 \text{ Nm}$ [11.4 ft-lbs] $\pm 10\%$
With different friction coefficients, the tightening torques can be adjusted accordingly!
- It must be ordered separately, if connection plate is needed. Type:**
- | | |
|-----------------|--------------------|
| G 66/01 (G3/8) | G 66/02 (M18×1.5) |
| G 67/01 (G1/2) | G 67/02 (M22×1.5) |
| G 534/01 (G3/4) | G 534/02 (M27×1.5) |

Notice:

1. Deviating from ISO 4401, port T is called TA and port T1 is called TB in this data sheet.
2. The dimensions are nominal dimensions which are subject to tolerances.